



**CATALOGO PRODOTTI
ITALIA
EQUILIBRATRICI
e Accessori originali**

IN VIGORE DA GENNAIO 2024













ED. NOVEMBRE 2024

TABELLA COLORI

1) Il colore standard dei ns. sollevatori è il rosso RAL 3002 (/15 o /16).

2) Ogni altra RICHIESTA di colorazione speciale in base alla tabella standard è a pagamento

(i prezzi sono indicati in righe specifiche all'interno del listino stesso a seconda della gamma di sollevamento scelta).

	RAL 3002 Corghi	/16
	RAL 3000 Rosso Citroen	/12
	RAL 7015 Grigio Mercedes	/52
	RAL 7011 Grigio Mercedes	/33
	RAL 7012 Grigio Mercedes	/65
	RAL 7040 Grigio Volkswagen / Fiat / Porsche	/39
	RAL 7030 Grigio Maserati / Ferrari	/69
	RAL 7016 Grigio BMW	/34 (bucciato)
	RAL 5011 Blu Peugeot	/A4 o /22 (bucciato)
	RAL 1003 Giallo Renault	/45
	RAL 7042 Grigio Renault	/38
	RAL 9005 Nero Lamborghini	/90 (bucciato)

Colorazioni differenti subordinate a conferma dell'Ufficio Commerciale.

Nexion SpA si riserva il diritto di cambiare le specifiche dei suoi prodotti in ogni momento senza necessità di preavviso. L'azienda declina ogni responsabilità in caso di reclami derivanti dall'uso di accessori o ricambi non originali con conseguente decadenza della dichiarazione CE di conformità.

EQUILIBRATRICI A BANCO PER AUTO

EYE-LIGHT PLUS DIAGNOSTICLINE
 EM 9980C PLUS DIAGNOSTICLINE
 EM 9780C PLUS AUTOMATICLINE
 EM 9780 PLUS AUTOMATICLINE
 EM 9580 C PLUS TOUCHSCREEN
 EM 9580 PLUS TOUCHSCREEN
 EM 9580 C PLUS LASERLINE
 EM 9580 PLUS LASERLINE
 EM 9550 C PLUS LASERLINE
 EM 9550 PLUS LASERLINE
 EM 9380 C XLINE TOUCHSCREEN
 EM 9380 XLINE TOUCHSCREEN
 EM 9380 C XLINE
 EM 9380 XLINE
 EM 9350 C XLINE
 EM 9350 XLINE
 EM 9280 C COMPACTLINE
 EM 9280 COMPACTLINE
 EM 9250 C COMPACTLINE
 EM 9250 COMPACTLINE

EQUILIBRATRICI A BANCO PER MOTO

EM 9250 BASIC BIKELINE
 ACCESSORI EQUILIBRATRICI A BANCO PER AUTO E MOTO

EQUILIBRATRICI PER IL SERVIZIO MOBILE

EM 9050 SPACESAVER
 EM 9050 - TILT UP - HAND SPIN
 EM 9050 - SLIDE - MOTORIZED SPIN
 EM 9050 WORKBENCH
 ACCESSORI EQUILIBRATRICI PER IL SERVIZIO MOBILE

4 EQUILIBRATRICI PER IL SERVIZIO MOBILE DA AUTOCARRI

4 ET 1050 MOBILE TRUCK
 5 ACCESSORI RACCOMANDATI PER ET 1050 MOBILE TRUCK

8 EQUILIBRATRICI A BANCO PER AUTOCARRI

8 ET 1680 TRUCKLINE TOUCHSCREEN
 9 ET 1650 TRUCKLINE
 10 ET 1450 TRUCKLINE
 11 ET 88
 12 ET 77
 13 ACCESSORI EQUILIBRATRICI A BANCO PER AUTOCARRI

24

24
 25

52

52
 53
 54
 55
 56

59

59
 60

61

61
 62
 63
 64
 65
 66

EYE-LIGHT PLUS DIAGNOSTICLINE



DOTAZIONE

SLUG
COD. 8-21100221



COD.
802227308



COD.
8-21100142



COD. 5-121236

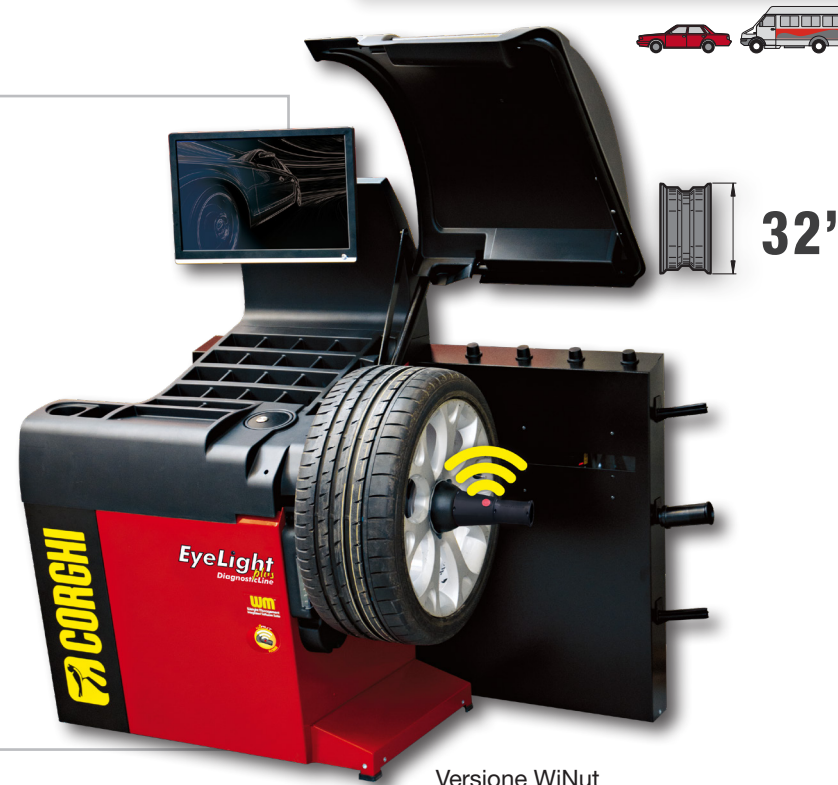

Versione WiNut

Codice	Alimentazione	Descrizione
0-21101101/16	100-230V / 1Ph / 50-60Hz	Equilibratrice diagnostica per gommisti, concessionari, autofficine e case automobilistiche. Monitor touchscreen da 22"; Misura dimensioni senza contatto con doppio triangolatore laser; Puntatore laser puntiforme in posizione ergonomica; Carter di protezione ruota salvaspazio (zero-space) ad apertura automatica; Pc industriale, telecamera, Diagnosi completa (eccentricità radiale e laterale, consumo battistrada e deriva ruota); iPos per il posizionamento intelligente del treno ruote; Weight management; Bloccaggio ruota automatico con esclusivo sistema wireless WiNut.
0-21101100/16	100-230V / 1Ph / 50-60Hz	Come sopra ma dotata di bloccaggio ruota automatico comandato a pedale.

EM 9980C PLUS DIAGNOSTICLINE



DOTAZIONE

COD.
8-21100221

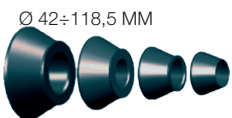

Ø 42÷118,5 MM



X3

PER VERSIONE
WINUT



COD.
8-21100142



COD.
802227308

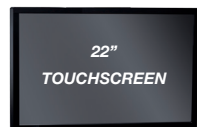

COD. 5-121236



32"



Versione WiNut



Codice	Alimentazione	Descrizione
0-21109984/16	100-230V / 1Ph / 50-60Hz	Equilibratrice diagnostica per gommisti, concessionari, autofficine e case automobilistiche. Monitor touchscreen da 22"; Misura dimensioni senza contatto con doppio triangolatore laser; Puntatore laser puntiforme in posizione ergonomica; Carter di protezione ruota salvaspazio (zero-space); Diagnosi dell'eccentricità radiale e laterale della ruota; iPos Lite per il posizionamento intelligente del treno ruote; Weight management; Bloccaggio ruota automatico con esclusivo sistema wireless WiNut.
0-21109983/16	100-230V / 1Ph / 50-60Hz	Come sopra ma dotata di bloccaggio ruota automatico comandato a pedale.

EM 9780C PLUS AUTOMATICLINE



DOTAZIONE

COD.
8-21100221



Ø 42÷118,5 MM



X3



PER VERSIONE
WINUT



COD.
802227308

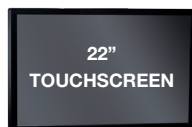

COD. 5-121236

COD.
8-21100142



32"



Codice	Alimentazione	Descrizione
0-21109784/16	100-230V / 1Ph / 50-60Hz	Equilibratrice automatica per gommisti, concessionari, autofficine e case automobilistiche. Monitor touchscreen da 22"; Misura dimensioni senza contatto con sistema combinato LASER-SONAR; Puntatore laser puntiforme in posizione ergonomica; carter di protezione ruota salvaspazio (zero-space); iPos Lite per il posizionamento intelligente del treno ruote; Weight management; Bloccaggio ruota automatico con esclusivo sistema wireless WiNut. Diagnosi ruota, Dispenser contrappesi e colonna porta boccole opzionali.
0-21109783/16	100-230V / 1Ph / 50-60Hz	Come sopra ma dotata di bloccaggio ruota automatico comandato a pedale.

EM 9780 PLUS AUTOMATICLINE



DOTAZIONE

COD.
8-21100221



Ø 42÷118,5 MM

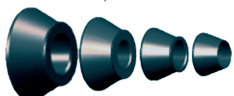

X3



32"

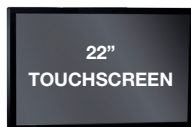

COD. 5-121236

COD.
8-21100142



COD.
802227308



Codice	Alimentazione	Descrizione
0-21109790/16	100-230V / 1Ph / 50-60Hz	Equilibratrice automatica per gommisti, concessionari, autofficine e case automobilistiche. Monitor touchscreen da 22"; Misura dimensioni senza contatto con sistema combinato LASER-SONAR; Puntatore laser puntiforme in posizione ergonomica; carter di protezione ruota salvaspazio (zero-space); iPos Lite per il posizionamento intelligente del treno ruote; Weight management; Bloccaggio ruota manuale. Diagnosi ruota, Dispenser contrappesi e colonna porta boccole opzionali.

EM 9580 C PLUS TOUCHSCREEN

DOTAZIONE

COD.
8-11100221

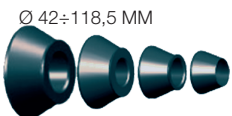

COD.
8-21100159



COD.
802227308



PER VERSIONE
WINUT



COD. 5-121236



COD.
8-21100142



TOUCHSCREEN



28"

Codice	Alimentazione	Descrizione
0-21109592/16	100-230V / 1Ph / 50-60Hz	<p>Equilibratrice dotata di monitor touchscreen industriale da 22", puntatore LaserLine, illuminatore Led, serraggio automatico della ruota, bloccaggio ruota automatico wireless (WiNUT), rilevatore SmartArm 28" intelligente con selezione automatica dei programmi con FST Fast Selection Program, LaserBlade per la selezione assistita dei piani di equilibratura, protezione ruota "Zero Space", Weight Management; Sonar AWD della larghezza e kit diagnosi sonar RunOut NON inclusi</p> <p>Sistema esclusivo di bloccaggio Wireless</p>
0-21109591/16	100-230V / 1Ph / 50-60Hz	Come sopra ma dotata di bloccaggio ruota automatico comandato a pedale.

EM 9580 PLUS TOUCHSCREEN



DOTAZIONE

COD.
8-11100221



COD.
802227308

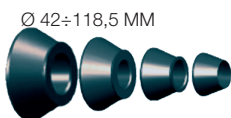

Ø 42÷118,5 MM

COD.
8-21100159



COD.
8-21100142



X3



COD. 5-121236

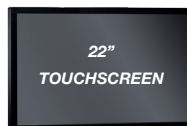

TOUCHSCREEN



28"

Codice	Alimentazione	Descrizione
0-21109590/16	100-230V / 1Ph / 50-60Hz	Equilibratrice dotata di monitor touchscreen industriale da 22", puntatore LaserLine, illuminatore LEd, serraggio manuale della ruota, rilevatore SmartArm 28" intelligente con selezione automatica dei programmi con FST Fast Selection Program, LaserBlade per la selezione assistita dei piani di equilibratura, protezione ruota "Zero Space", Weight Management; Sonar AWD della larghezza e kit diagnosi sonar RunOut NON inclusi

EM 9580 C PLUS LASERLINE



DOTAZIONE

COD.
8-11100221



Ø 42÷118,5 MM

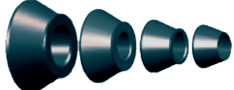

X3



PER VERSIONE
WINUT



COD.
802227308



COD.
8-21100159



COD.
8-21100142



28"

Codice	Alimentazione	Descrizione
0-21109588/16	100-230V / 1Ph / 50-60Hz	Equilibratrice con puntatore LaserLine , bloccaggio ruota automatico wireless (WiNUT), selezione automatica dei programmi con Fast Selection Program, protezione ruota "Zero Space", Weight Management, (monitor e sonar della larghezza NON inclusi) Sistema esclusivo di bloccaggio Wireless
0-21109586/16	100-230V / 1Ph / 50-60Hz	Equilibratrice con puntatore LaserLine , bloccaggio ruota automatico, selezione automatica dei programmi con Fast Selection Program, protezione ruota "Zero Space", Weight Management, (monitor e sonar della larghezza NON inclusi)

EM 9580 PLUS LASERLINE



DOTAZIONE

COD.
8-21100221



Ø 42÷118,5 MM

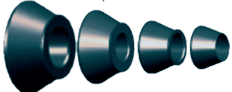

COD.
802227308



COD.
8-21100159



X3



COD.
8-21100142



28"



Codice	Alimentazione	Descrizione
0-21109587/16	100-230V / 1Ph / 50-60Hz	Equilibratrice con puntatore LaserLine , bloccaggio ruota manuale, selezione automatica dei programmi con Fast Selection Program, protezione ruota "Zero Space", Weight Management, (monitor e sonar della larghezza NON inclusi)

EM 9550 C PLUS LASERLINE



DOTAZIONE

COD.
8-21100221



Ø 42÷118,5 MM

COD.
802227308



X3

COD.
8-21100159



28"

Codice	Alimentazione	Descrizione
0-21109556/16	100-230V / 1Ph / 50-60Hz	Equilibratrice a display LCD con puntatore LaserLine , bloccaggio ruota automatico, selezione automatica dei programmi con Fast Selection Program, protezione ruota "Zero Space", (sonar della larghezza NON incluso)

EM 9550 PLUS LASERLINE



DOTAZIONE

COD.
8-21100221



Ø 42÷118,5 MM

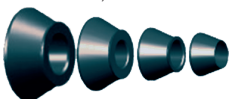

COD.
802227308

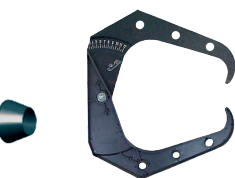

X3



COD.
8-21100159



28"

Codice	Alimentazione	Descrizione
0-21109557/16	100-230V / 1Ph / 50-60Hz	Equilibratrice a display LCD con puntatore LaserLine , bloccaggio ruota manuale, selezione automatica dei programmi con Fast Selection Program, protezione ruota "Zero Space", (sonar della larghezza NON incluso)

EM 9380 C XLINE TOUCHSCREEN



DOTAZIONE

COD.
8-21100221



Ø 42÷118,5 MM

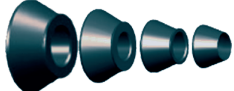

X3



COD.
802227308



COD. 5-121236

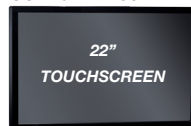

Codice	Alimentazione	Descrizione
0-21193806/16	200-230V/1Ph/50-60Hz	Equilibratrice con monitor touchscreen 22, puntatore LaserLine, illuminatore Led, serraggio automatico della ruota, rilevatore SmartArm 28", Weight Management. Sonar AWD della larghezza NON incluso

EM 9380 XLINE TOUCHSCREEN



DOTAZIONE

COD.
8-21100221



Ø 42÷118,5 MM

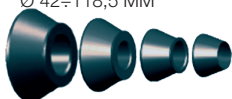

COD.
802227308



X3



COD. 5-121236

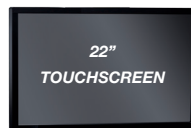

28"

TOUCHSCREEN

Codice	Alimentazione	Descrizione
0-21193805/16	200-230V/1Ph/50-60Hz	Equilibratrice con monitor touchscreen 22, puntatore LaserLine, illuminatore Led, serraggio manuale della ruota, rilevatore SmartArm 28, Weight Management. Sonar AWD della larghezza NON incluso

EM 9380 C XLINE



DOTAZIONE

COD.
8-21100221



Ø 42÷118,5 MM

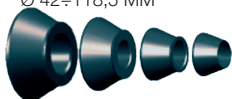

COD.
802227308



28"

Codice	Alimentazione	Descrizione
0-21193802/16	200-230V / 1Ph / 50-60Hz	Equilibratrice con indicatore Laser e acquisizione elettronica dei dati con FSP (monitor NON incluso) , Weight Management, kit centraggio Ø 42÷118,5mm, sistema automatico di bloccaggio ruota.

EM 9380 XLINE



DOTAZIONE

COD.
8-21100221



Ø 42÷118,5 MM

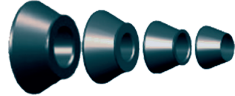

X3



COD.
802227308

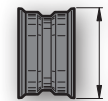

28"

Codice	Alimentazione	Descrizione
0-21193800/16	200-230V / 1Ph / 50-60Hz	EM9380 Xline , Equilibratrice con indicatore Laser e acquisizione elettronica dei dati con FSP (monitor NON incluso), Weight Management, kit centraggio ø 42÷118,5mm

EM 9350 C XLINE



DOTAZIONE

COD.
8-21100221



Ø 42÷118,5 MM

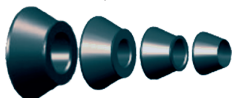

COD.
802227308



28"

Codice	Alimentazione	Descrizione
0-21193502/16	200-230V / 1Ph / 50-60Hz	EM9350 Xline Equilibratrice a display LCD con indicatore Laser e acquisizione automatica dei dati con FSP, sistema automatico di bloccaggio ruota.

EM 9350 XLINE



DOTAZIONE

COD.
8-21100221



Ø 42÷118,5 MM

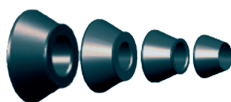

X3



COD.
802227308



28"

Codice	Alimentazione	Descrizione
0-21193500/16	200-230V / 1Ph / 50-60Hz	EM9350 Xline Equilibratrice a display LCD con indicatore Laser e acquisizione automatica dei dati con FSP

EM 9280 C COMPACTLINE

DOTAZIONE

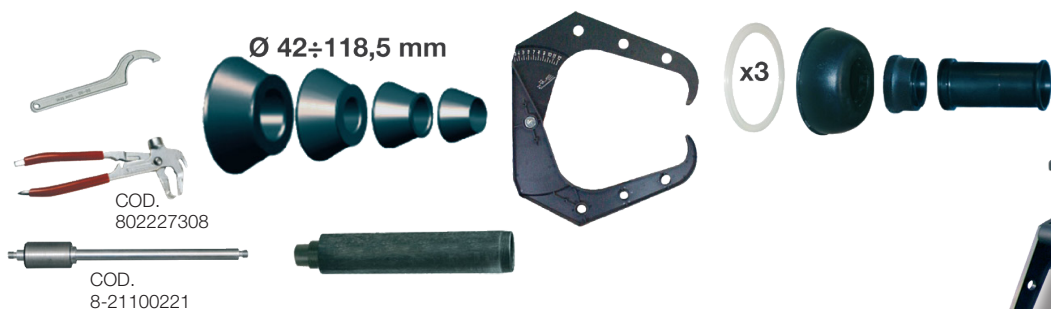

Codice	Alimentazione	Descrizione
0-21192804/16	200-230V / 1Ph / 50-60Hz	EM9280 C CompactLine , Equilibratrice, compatta ed essenziale con performances professionali; Bloccaggio ruota automatico (pneumatico-brevettato); Semplice e veloce da usare; Acquisizione automatica delle dimensioni ruota distanza e diametro con funzione SMARTARM per il riconoscimento automatico del programma di equilibratura ottimale; AWC (Auto Width Calculation): calcolo automatico della larghezza ruota anche in assenza del sensore esterno AWD; Freno automatico a fine misura; Rpa system - Ricerca della posizione automatica del peso e freno di stazionamento automatico; Ottimizzazione rapida, Peso nascosto e programma divisione peso per moto; 4 coni (42÷118,5mm); Monitor e piede laterale non inclusi

EM 9280 COMPACTLINE



DOTAZIONE

COD.
8-21100221

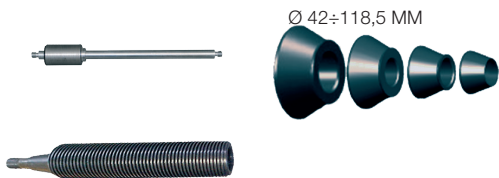

COD.
802227308



Codice	Alimentazione	Descrizione
0-21192800/16	200-230V / 1Ph / 50-60Hz	Equilibratrice con acquisizione automatica dei dati, freno automatico a fine lancio, sistema RPA (monitor NON incluso), Weight Management

EM 9250 C COMPACTLINE



DOTAZIONE

COD.
8-21100221



Ø 42÷118,5 MM

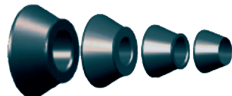

X3



COD.
802227308



Codice	Alimentazione	Descrizione
0-21192513/16	200-230V / 1Ph / 50-60Hz	EM9250-C PREMIUM VERSION Equilibratrice a display LCD con acquisizione automatica dei dati, freno automatico a fine misura, PNEULOCK serraggio ruota automatico, AWC Auto Width Calculation, sistema RPA

EM 9250 COMPACTLINE



DOTAZIONE

COD.
8-21100221

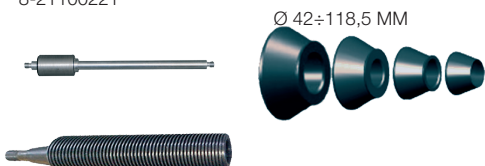

X3



COD.
802227308



Versione Premium

Codice	Alimentazione	Descrizione
0-21192508/16	200-230V / 1Ph / 50-60Hz	Versione PREMIUM: Equilibratrice a display con acquisizione automatica dei dati ruota FSP, freno di stazionamento elettrico, sistema RPA, dispositivo AWD sonar disponibile, a richiesta, su questa versione
0-21192504/16	200-230V / 1Ph / 50-60Hz	Versione PROFESSIONAL: Equilibratrice a display con acquisizione automatica dei dati ruota FSP, AWC per la larghezza approssimata, (dispositivo AWD sonar NON disponibile come accessorio per questa versione)
0-21192500/16	200-230V / 1Ph / 50-60Hz	Versione BASIC: Equilibratrice a display con acquisizione manuale dei dati ruota

EM 9250 BASIC BIKELINE

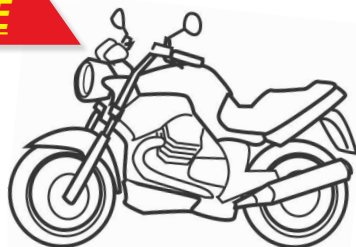

DOTAZIONE

COD.
8-21100221

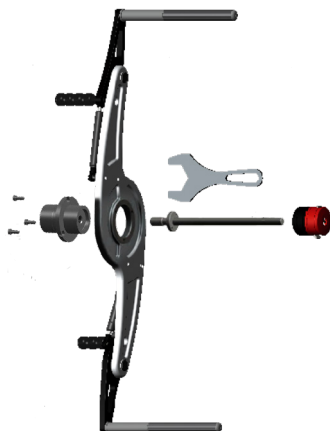

COD.
802227308







Codice	Alimentazione	Descrizione
0-21192512/16	200-230V / 1Ph / 50-60Hz	EM 9250 Basic BikeLine Equilibratrice a display con acquisizione manuale dei dati. Completa di BIKE UNIVERSAL KIT e PRA4

ACCESSORI EQUILIBRATICI A BANCO PER AUTO E MOTO

Immagine	Descrizione	Codice	EYE-LIGHT PLUS	EM9980 C PLUS	EM9780 C PLUS	EM9780 PLUS LINE	EM9580 C PLUS TOUCHSCREEN	EM9580 PLUS TOUCHSCREEN	EM9580 C PLUS	EM9580 PLUS	EM9550 C PLUS	EM9550 PLUS	EM9380 C / TOUCHSCREEN	EM9380 / TOUCHSCREEN	EM9350 C	EM9350	EM9280 C	EM9280	EM9250 C PREMIUM	EM9250 PREMIUM	EM9250 PROFESSIONAL	EM9250 BASIC	EM9250 BASIC BIKELINE
MONITOR																							
	Monitor wide-screen 22" (non per versione Touchscreen)	8-21100234	-	-	-	-	-	-	O	O	-	-	O	O	-	-	-	-	-	-	-	-	-
	Monitor wide-screen 19" (non per versione Touchscreen)	8-21100235	-	-	-	-	-	-	O	O	-	-	O	O	-	-	O	O	-	-	-	-	-

ACCESSORI EQUILIBRATICI A BANCO PER AUTO E MOTO

Immagine	Descrizione	Codice	EYE-LIGHT PLUS	EM9980 C PLUS	EM9780 C PLUS	EM9780 PLUS LINE	EM9560 C PLUS TOUCHSCREEN	EM9560 PLUS TOUCHSCREEN	EM9560 C PLUS	EM9560 PLUS	EM9550 C PLUS	EM9550 PLUS	EM9380 C / TOUCHSCREEN	EM9380 / TOUCHSCREEN	EM9350 C	EM9350	EM9280 C	EM9280	EM9250 C PREMIUM	EM9250 PREMIUM	EM9250 PROFESSIONAL	EM9250 BASIC	EM9250 BASIC BIKE LINE
	Kit di pulizia monitor	8-21120006	0	0	0	0	0	0	0	0	-	-	0	0	-	-	0	0	-	-	-	-	-
DISPOSITIVI ELETTRONICI																							
 LAN CONNECTION KIT	Kit collegamento LAN	8-21100255	0	0	0	0	0	0	0	0	-	-	0	0	-	-	0	0	-	-	-	-	-
	EG1 rilevatore larghezza ruota con supporto	8-21100074	-	-	-	-	-	-	-	-	-	-	-	-	-	-	-	-	-	-	0	-	-
	KIT LASER BLADE puntatore laser integrato nel braccio rilevatore digitale interno, diametro/distanza per guidare l'operatore nella scelta dei piani interni del cerchio senza commettere errori e con estrema visibilità. Sistema Plug&Play dedicato.	8-21120022	-	-	-	-	-	-	-	-	-	-	0	0	0	0	0	0	0	0	0	0	0

ACCESSORI EQUILIBRATICI A BANCO PER AUTO E MOTO

Immagine	Descrizione	Codice	EYE-LIGHT PLUS	EM9980 C PLUS	EM9780 C PLUS	EM9780 PLUS LINE	EM9880 C PLUS TOUCHSCREEN	EM9580 PLUS TOUCHSCREEN	EM9580 C PLUS	EM9580 PLUS	EM9550 C PLUS	EM9550 PLUS	EM9380 C / TOUCHSCREEN	EM9380 / TOUCHSCREEN	EM9350 C	EM9350	EM9280 C	EM9280	EM9250 C PREMIUM	EM9250 PREMIUM	EM9250 PROFESSIONAL	EM9250 BASIC	EM9250 BASIC-BIKELINE
	KIT upgrade LASER BLADE serie EM95xx (accessorio di serie sulle EM9550-EM9580 versione PLUS, permette l'upgrade dei modelli non in versione PLUS prodotti fino a fine 2017)	8-21120023	-	-	-	-	■	■	■	■	■	■	-	-	-	-	-	-	-	-	-	-	-
	KIT LASER & LED indicatore LASER e illuminatore LED	8-21100238	-	-	-	-	-	-	-	-	-	-	-	-	-	-	○	○	○	○	○	○	-
	AWD misuratore della larghezza ruota con Sonar Compatibile con i modelli di equilibratrici prodotti da luglio 2024	8-21100293/90	-	-	■	■	○	○	○	○	○	○	○	○	○	○	○	○	○	○	-	-	-
	kit retrofit WINUT per aggiungere il sistema WINUT ad una equilibratrice nata senza; per i modelli della serie EM92xx-C e EM93xx-C si pate da Luglio 2019	8-21100242	○	○	○	-	○	-	○	-	-	-	○	-	○	-	○	-	○	-	-	-	-
	RRS Sonar RUN-OUT per la misurazione dell'eccentricità della ruota. Nei modelli touchscreen, oltre alla visualizzazione grafica dei dati, è inclusa anche la funzione BESTFIT.	8-21100250	-	-	○	○	○	○	○	○	-	-	-	-	-	-	-	-	-	-	-	-	-



ACCESSORI EQUILIBRATICI A BANCO PER AUTO E MOTO

Immagine	Descrizione	Codice	EYE-LIGHT PLUS	EM9980 C PLUS	EM9780 C PLUS	EM9780 PLUS LINE	EM9680 C PLUS TOUCHSCREEN	EM9680 PLUS TOUCHSCREEN	EM9680 C PLUS	EM9680 PLUS	EM9650 C PLUS	EM9650 PLUS	EM9880 C / TOUCHSCREEN	EM9880 / TOUCHSCREEN	EM9350 C	EM9350	EM9280 C	EM9280	EM9250 C PREMIUM	EM9250 PREMIUM	EM9250 PROFESSIONAL	EM9250 BASIC	EM9250 BASIC BIKE LINE
SOLLEVATORI																							
	TT-ZERO GRAVITY Sollevatore ruota automatico autobilanciato, portata 80 kg	8-21100230	○	○	○	○	○	○	○	○	○	○	○	○	○	○	○	○	○	○	○	○	○
	TTT-R Sollevatore ruote professionale regolabile manualmente, portata 80 kg	8-21100248	○	○	○	○	○	○	○	○	○	○	○	○	○	○	○	○	○	○	○	○	○



ACCESSORI EQUILIBRATRICI A BANCO PER AUTO E MOTO

Immagine	Descrizione	Codice	EYE-LIGHT PLUS	EM9980 C PLUS	EM9780 C PLUS	EM9780 PLUS LINE	EM9660 C PLUS TOUCHSCREEN	EM9660 PLUS TOUCHSCREEN	EM9660 C PLUS	EM9660 PLUS	EM9650 C PLUS	EM9650 PLUS	EM9380 C / TOUCHSCREEN	EM9380 / TOUCHSCREEN	EM9350 C	EM9350	EM9280 C	EM9280	EM9250 C PREMIUM	EM9250 PREMIUM	EM9250 PROFESSIONAL	EM9250 BASIC	EM9250 BASIC BIKE LINE
	kit montaggio per sollevatori TT-ZERO GRAVITY e TT-R solo per EM9380 e EM9350, EM9280 e EM9250	8-21100231	-	-	-	-	-	-	-	-	-	-	O	O	O	O	O	O	O	O	O	O	O
	Kit Flap per sollevatori TT-ZERO GRAVITY e TT-R (permette di installare il sollevatore su equilibratrici dotate di piede laterale)	8-21600132	-	-	-	-	-	-	-	-	-	-	-	-	-	-	O	O	O	O	O	O	O
	TT - Ø Sollevatore ruota automatico e autobilanciato per equilibratrici NON a marchio Corghi, portata 80 kg.	0-21608806	-	-	-	-	-	-	-	-	-	-	-	-	-	-	-	-	-	-	-	-	-



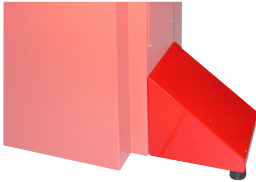

ACCESSORI EQUILIBRATICI A BANCO PER AUTO E MOTO

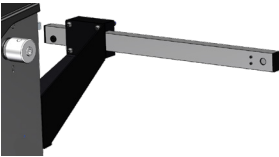
Immagine	Descrizione	Codice	PERSONALIZZAZIONI																			
			EYE-LIGHT PLUS	EM9980 C PLUS	EM9780 C PLUS	EM9780 PLUS LINE	EM9580 C PLUS TOUCHSCREEN	EM9580 PLUS TOUCHSCREEN	EM9580 C PLUS	EM9580 PLUS	EM9550 C PLUS	EM9550 PLUS	EM9380 C / TOUCHSCREEN	EM9380 / TOUCHSCREEN	EM9350 C	EM9350	EM9280 C	EM9280	EM9250 C PREMIUM	EM9250 PREMIUM	EM9250 PROFESSIONAL	EM9250 BASIC
	Pannello laterale porta accessori e boccole bifronte HPC : supporto accessori di centraggio e boccole; verniciato in rosso (solo per equilibratrici già verniciate di colore rosso RAL 3002 in /16)	8-21100258/16	-	-	-	-	-	-	-	-	-	-	-	-	-	0	0	0	0	0	0	0
	Pannello laterale porta accessori e boccole bifronte HPC : supporto accessori di centraggio e boccole; verniciato in nero (solo per equilibratrici verniciate di colore DIVERSO dal rosso RAL 3002 in /16)	8-21100258/90	-	-	-	-	-	-	-	-	-	-	-	-	-	-	0	0	0	0	0	0
	Supporto per HPC boccole bifronte verniciato in rosso (solo per equilibratrici già verniciate di colore rosso RAL 3002 in /16)	8-21100253/16	-	0	0	0	0	0	0	0	0	0	-	-	-	-	-	-	-	-	-	-
	Supporto per HPC boccole bifronte verniciato in nero (solo per equilibratrici verniciate di colore DIVERSO dal rosso RAL 3002 in /16)	8-21100253/90	■	0	0	0	0	0	0	0	0	0	-	-	-	-	-	-	-	-	-	-



ACCESSORI EQUILIBRATICI A BANCO PER AUTO E MOTO

Immagine	Descrizione	Codice																					
			EYE-LIGHT PLUS	EM9980 C PLUS	EM9780 C PLUS	EM9780 PLUS LINE	EM9680 C PLUS TOUCHSCREEN	EM9680 PLUS TOUCHSCREEN	EM9680 C PLUS	EM9680 PLUS	EM9550 C PLUS	EM9550 PLUS	EM9380 C / TOUCHSCREEN	EM9380 / TOUCHSCREEN	EM9350 C	EM9350	EM9280 C	EM9280	EM9250 C PREMIUM	EM9250 PREMIUM	EM9250 PROFESSIONAL	EM9250 BASIC	EM9250 BASIC BIKELINE
	PL 50 piede per installazioni senza fissaggio al pavimento verniciato in rosso (solo per equilibratrici già verniciate di colore rosso RAL 3002 in /16).	8-21100158/16	-	-	-	-	-	-	-	-	-	-	-	-	-	0	0	0	0	0	0	0	0
	PL 50 piede per installazioni senza fissaggio al pavimento verniciato in nero (solo per equilibratrici verniciate di colore DIVERSO dal rosso RAL 3002 in /16).	8-21100158/90	-	-	-	-	-	-	-	-	-	-	-	-	-	0	0	0	0	0	0	0	0
	Kit personalizzazione colore per pannello frontale per serie EM9250 e EM9280 CompactLine	8-21100245/xx	-	-	-	-	-	-	-	-	-	-	-	-	0	0	0	0	0	0	0	0	
VARIE																							
	RRS-2 Kit Sonar RUN-OUT consente di controllare lo stato dell'eccentricità della ruota attraverso un sistema di icone colorate sulla schermata principale	8-21100277	-	-	-	-	-	-	-	-	-	-	0	0	-	-	0	0	-	-	-	-	

ACCESSORI EQUILIBRATICI A BANCO PER AUTO E MOTO

Immagine	Descrizione	Codice																					
			EYE-LIGHT PLUS	EM9980 C PLUS	EM9780 C PLUS	EM9780 PLUS LINE	EM9660 C PLUS TOUCHSCREEN	EM9660 PLUS TOUCHSCREEN	EM9660 C PLUS	EM9660 PLUS	EM9650 C PLUS	EM9650 PLUS	EM9380 C / TOUCHSCREEN	EM9380 / TOUCHSCREEN	EM9350 C	EM9350	EM9280 C	EM9280	EM9250 C PREMIUM	EM9250 PREMIUM	EM9250 PROFESSIONAL	EM9250 BASIC	EM9250 BASIC BIKE LINE
	DISPENSER KIT: pratico dispenser per rotolo contrappesi adesivi	8-21100251	○	○	○	○	○	○	○	○	○	○	○	○	○	○	○	○	○	○	○	○	○
	BOBINA CONTRAPPESI adesivi: rotolo in ferro 5 gr x 1200 - 6 kg.	8-21100252	○	○	○	○	○	○	○	○	○	○	○	○	○	○	○	○	○	○	○	○	○
	CB Freno a pedale.	8-21100191	-	-	-	-	-	-	-	-	-	-	-	-	-	-	-	-	-	-	○	○	○
	AWR Utensile per la rimozione dei pesi adesivi	802461006	○	○	○	○	○	○	○	○	○	○	○	○	○	○	○	○	○	○	○	○	○
	PFC Pinza per contrappesi	802227308	■	■	■	■	■	■	■	■	■	■	■	■	■	■	■	■	■	■	■	■	■

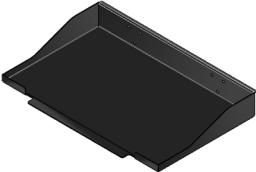
ACCESSORI EQUILIBRATICI A BANCO PER AUTO E MOTO

Immagine	Descrizione	Codice																					
			EYE-LIGHT PLUS	EM9980 C PLUS	EM9780 C PLUS	EM9780 PLUS LINE	EM9580 C PLUS TOUCHSCREEN	EM9580 PLUS TOUCHSCREEN	EM9580 C PLUS	EM9580 PLUS	EM9550 C PLUS	EM9550 PLUS	EM9380 C / TOUCHSCREEN	EM9380 / TOUCHSCREEN	EM9350 C	EM9350	EM9280 C	EM9280	EM9250 C PREMIUM	EM9250 PREMIUM	EM9250 PROFESSIONAL	EM9250 BASIC	EM9250 BASIC BIKE LINE
	PR Stampante Inkjet colore usb	8-21120005	O	O	O	O	O	O	-	-	-	-	-	-	-	-	-	-	-	-	-	-	-
	PRS Kit supporto stampante	8-21100236/90	O	O	O	O	O	O	-	-	-	-	-	-	-	-	-	-	-	-	-	-	-
	Clip per il posizionamento assistito dei pesi adesivi solo per EM92XX CompactLine e EM93XX XLine	8-21100159	-	-	-	-	■	■	■	■	■	■	■	O	O	O	O	O	O	O	O	O	O
	PPT Pinza premitallone	8-21100225	O	O	O	O	O	O	O	O	O	O	O	O	O	O	O	O	O	O	O	O	O
	ASF Kit - Adjustable Stability Foot, ottimizza la stabilità dell'equilibratrice in caso di contatti accidentali da parte dell'operatore	8-21100299	O	O	O	O	O	O	O	O	O	O	O	O	O	O	O	O	O	O	O	O	O

NEW!





ACCESSORI EQUILIBRATICI A BANCO PER AUTO E MOTO

Immagine	Descrizione	Codice	EYE-LIGHT PLUS	EM9980 C PLUS	EM9780 C PLUS	EM9780 PLUS LINE	EM9580 C PLUS TOUCHSCREEN	EM9580 PLUS TOUCHSCREEN	EM9580 C PLUS	EM9580 PLUS	EM9550 C PLUS	EM9550 PLUS	EM9380 C / TOUCHSCREEN	EM9380 / TOUCHSCREEN	EM9350 C	EM9350	EM9280 C	EM9280	EM9250 C PREMIUM	EM9250 PREMIUM	EM9250 PROFESSIONAL	EM9250 BASIC	EM9250 BASIC BIKE LINE
CENTRAGGIO RUOTA																							
	GBP40 EVO KIT - Kit ghiera rapida di bloccaggio professional Ø40x3mm	8-21100289	-	-	-	■	-	■	-	■	-	■	-	■	-	■	-	■	-	■	■	■	○
	PCF1 PROTEZIONE CERCHI IN LEGA	4-115868																					
	CF1 CALOTTA FISSAGGIO RUOTA	4-115863																					
	CD1 CAPPELLOTTO DISTANZIALE	4-115864																					
	GBP EVO GHIERA RAPIDA	5-101561																					
	GBP1 CRICCHETTO DX	4-104798																					
	GBP2 CRICCHETTO SX	4-104799																					
	GBP3 LEVA	4-104796																					
	CCK3 EVO KIT - Kit coni di centraggio Ø40mm 42÷103,5mm	8-21100280	■	■	■	■	■	■	■	■	■	■	■	■	■	■	■	■	■	■	■	■	○
	CP1 CONO PICCOLO Ø42÷68 MM	5-107970																					
	CP2 CONO MEDIO Ø60÷87 MM	5-107968																					
	CP3 CONO GRANDE Ø83÷103 MM	5-107969																					
	MFS - Mozzo filettato standard Ø40x3mm - 181,5mm	8-21100283	-	-	-	■	-	■	-	■	-	■	-	■	-	■	-	■	-	■	■	■	○
	MFL - Mozzo filettato XL Ø40x3mm - 220mm	8-21100193	-	-	-	○	-	○	-	○	-	○	-	○	-	○	-	○	-	○	○	○	○
	MBP40 EVO KIT - Kit maniglia per bloccaggio ruote elettrico o pneumatico	8-21100285	■	■	■	-	■	-	■	-	■	-	■	-	■	-	■	-	■	-	-	-	-
	PCF1 PROTEZIONE CERCHI IN LEGA	4-115868																					
	CF1 CALOTTA FISSAGGIO RUOTA	4-115863																					
	CD1 CAPPELLOTTO DISTANZIALE	4-115864																					
	QLS MANICOTTO	5-107394																					

ACCESSORI EQUILIBRATICI A BANCO PER AUTO E MOTO

Immagine	Descrizione	Codice	EYE-LIGHT PLUS	EM9980 C PLUS	EM9780 C PLUS	EM9780 PLUS LINE	EM8680 C PLUS TOUCHSCREEN	EM8680 PLUS TOUCHSCREEN	EM8680 C PLUS	EM8680 PLUS	EM8650 C PLUS	EM8650 PLUS	EM8380 C / TOUCHSCREEN	EM8380 / TOUCHSCREEN	EM8350 C	EM8350	EM8280 C	EM8280	EM8250 C PREMIUM	EM8250 PREMIUM	EM8250 PROFESSIONAL	EM8250 BASIC	EM8250 BASIC BIKE LINE		
CENTRAGGIO RUOTA																									
	SBC serie di 6 boccole centraggio	8-21100082	○	○	○	○	○	○	○	○	○	○	○	○	○	○	○	○	○	○	○	○	○		
	B1 AUDI, BMW, CHRYSLER, OPEL, ROVER, SEAT, VW, DAEWOO, GALAXY (FORD), LOTUS, BRITISH-LEYLAND, SMART (MERCEDES), SKODA	4-105075																							
	B2 CITRÖEN, HYUNDAI, LANCIA, MASERATI, MAZDA, MERCEDES, MITSUBISHI, NISSAN, OPEL, PEUGEOT, SAAB, VOLVO.	4-105076																							
	B3 BMW, JAGUAR, ASTON MARTIN.	4-105077																							
	B4 FORD, HONDA, ROVER	4-105078																							
	B5 AUTOBIANCHI, ALFA ROMEO, CITRÖEN, FIAT, LADA, LANCIA, JALBOT, BITURBO (MASERATI), MAZDA, NISSAN, PEUGEOT, PORSCHE, RENAULT, 2600-3500 SERIE (ROVER), SEAT =>90, SKODA, TOYOTA.	4-105079																							
	B7 CITRÖEN, DAIHATSU, HONDA, KIA, MAZDA, MITSUBISHI, PEUGEOT, ROVER, SUBARU, TOYOTA, AGILA (OPEL), SUZUKI, HYUDAY.	4-105080																							
	HPC Set di 8 boccole bifronte a bassa conicità per il centraggio ottimale di ruote da autovetture, SUV e pick up	8-21100244	■	○	○	○	○	○	○	○	○	○	○	○	○	○	○	○	○	○	○	○	○		

ACCESSORI EQUILIBRATICI A BANCO PER AUTO E MOTO

Immagine	Descrizione	Codice																					
			EYE-LIGHT PLUS	EM9980 C PLUS	EM9780 C PLUS	EM9780 PLUS LINE	EM8580 C PLUS TOUCHSCREEN	EM8680 PLUS TOUCHSCREEN	EM8580 C PLUS	EM8680 PLUS	EM8550 C PLUS	EM8550 PLUS	EM8380 C / TOUCHSCREEN	EM8380 / TOUCHSCREEN	EM8350 C	EM8350	EM8280 C	EM8280	EM8250 C PREMIUM	EM8250 PREMIUM	EM8250 PROFESSIONAL	EM8250 BASIC	EM8250 BASIC BIKELINE
 B11 B6	KIT BMW-MINI Ø 66.5, Ø 56.5, Ø 72.5, Ø 74 mm	8-21100228	○	○	○	○	○	○	○	○	○	○	○	○	○	○	○	○	○	○	○	○	○
	B6 Ø 66.5 MM	4-105103																					
	B11 Ø 56.5 - Ø 72.5 - Ø 74 MM	4-105108																					
 B16 B17	KIT MERCEDES ø 57 / 60 / 66,1 / 66,42 / 66,50 / 67 / 84 mm	8-21400022	○	○	○	○	○	○	○	○	○	○	○	○	○	○	○	○	○	○	○	○	○
	B16 Ø 57 / 66,1 / 66,42 / 66,50 / 67 MM	4-138168																					
	B17 Ø 60 / 84 MM	4-138169																					
CENTRAGGIO RUOTA																							
 CIP	CIP Cono intermedio Ø 55÷72 mm FONDAMENTALE PER RUOTE CON COPRI CERCHIO ESTETICO IN PLASTICA E CERCHI AFTERMARKET CON FORI DEL MOZZO CORTI. LE DIMENSIONI DEL CIP EVITANO CHE LO STESSO FUORIESCA ANTERIORMENTE DEL FORO DEL MOZZO, EVITANDO DANNEGGIAMENTI ALLE PARTI ANTERIORI DEL CERCHIO, IN QUESTI CERCHI IL DIAMETRO ANTERIORE DEL FORO DEL MOZZO È INFERIORE A QUELLO POSTERIORI DI CENTRAGGIO.	8-21100200	○	○	○	○	○	○	○	○	○	○	○	○	○	○	○	○	○	○	○	○	○
 CGF PCF1 CF1	ARF - Kit coni centraggio fuoristrada Ø 100 ÷118,5 mm, Ø 100 ÷129,5 mm	8-21100080	■	■	■	■	■	■	■	■	■	■	■	■	■	■	■	■	■	■	■	○	
	CGF - CONO FUORISTRADA (FURGONI)	4-103186																					
	PCF1 - PROTEZIONE PER CENTRAGGIO CERCHI IN LEGA	4-115868																					
	CF1 - CALOTTA FISSAGGIO RUOTA	4-115863																					

ACCESSORI EQUILIBRATICI A BANCO PER AUTO E MOTO

Immagine	Descrizione	Codice	EYE-LIGHT PLUS	EM9980 C PLUS	EM9780 C PLUS	EM9780 PLUS LINE	EM9660 C PLUS TOUCHSCREEN	EM9660 PLUS TOUCHSCREEN	EM9660 C PLUS	EM9660 PLUS	EM9650 C PLUS	EM9650 PLUS	EM9650 C / TOUCHSCREEN	EM9680 / TOUCHSCREEN	EM9350 C	EM9350	EM9280 C	EM9280	EM9250 C PREMIUM	EM9250 PREMIUM	EM9250 PROFESSIONAL	EM9250 BASIC	EM9250 BASIC BIKE LINE
	Cono di centraggio per cerchi con foro da Ø95 a Ø137 mm	8-21100096	○	○	○	○	○	○	○	○	○	○	○	○	○	○	○	○	○	○	○	○	○
 DX2 CST	CLT Accessorio per ruote SUV, VAN e furgoni Ø110÷132 mm	8-21100201	○	○	○	○	○	○	○	○	○	○	○	○	○	○	○	○	○	○	○	○	○
	DX2 DISTANZIALE 341843																						
CST CONO SUV & VAN & FURGONI 4-112320																							
 DX1 CF1 CF2	DX/CBF Accessorio di centraggio per furgoni e fuoristrada con foro centrale Ø117÷173 mm	8-21100141	○	○	○	○	○	○	○	○	○	○	○	○	○	○	○	○	○	○	○	○	○
	DX1 DISTANZIALE 4-107426																						
	CF1 CONO FURGONI Ø 117÷147 MM 4-107423																						
CF2 CONO FURGONI 143÷173 MM 4-107424																							

ACCESSORI EQUILIBRATICI A BANCO PER AUTO E MOTO

Immagine	Descrizione	Codice	EYE-LIGHT PLUS	EM9980 C PLUS	EM9780 C PLUS	EM9780 PLUS LINE	EM9680 C PLUS TOUCHSCREEN	EM9680 PLUS TOUCHSCREEN	EM9580 C PLUS	EM9680 PLUS	EM9550 C PLUS	EM9650 PLUS	EM9380 C / TOUCHSCREEN	EM9380 / TOUCHSCREEN	EM9350 C	EM9350	EM9280 C	EM9280	EM9250 C PREMIUM	EM9250 PREMIUM	EM9250 PROFESSIONAL	EM9250 BASIC	EM9250 BASIC BIKE LINE	
CENTRAGGIO RUOTA																								
<p>DX1 CF161</p>	DX1/CF161 Kit di centraggio professionale per veicoli commerciali Mercedes Benz Sprinter e Volkswagen Crafter con foro centrale Ø161 mm	8-21120004	○	○	○	○	○	○	○	○	○	○	○	○	○	○	○	○	○	○	○	○		
		4-107426																						
		4-131929																						
DISTANZIALI RUOTA																								
ARS	<p>DARS</p>	DM Distanziale riduttore per ruote MINI MORRIS Ø40 mm	8-21100088	○	○	○	○	○	○	○	○	○	○	○	○	○	○	○	○	○	○	○	○	







ACCESSORI EQUILIBRATICI A BANCO PER AUTO E MOTO

ACCESSORI EQUILIBRATICI A BANCO PER AUTO E MOTO				EYE-LIGHT PLUS	EM9980 C PLUS	EM9780 C PLUS	EM9780 PLUS LINE	EM9580 C PLUS TOUCHSCREEN	EM9580 PLUS TOUCHSCREEN	EM9580 C PLUS	EM9580 PLUS	EM9550 C PLUS	EM9550 PLUS	EM9380 C / TOUCHSCREEN	EM9380 / TOUCHSCREEN	EM9350 C	EM9350	EM9280 C	EM9280	EM9250 C PREMIUM	EM9250 PREMIUM	EM9250 PROFESSIONAL	EM9250 BASIC	EM9250 BASIC BIKELINE		
Immagine	Descrizione	Codice																								
	ARS Accessorio "Racing" per ruote sportive, da usare con boccia Racing	8-21100089		0	0	0	0	0	0	0	0	0	0	0	0	0	0	0	0	0	0	0	0	0		
BLOCCAGGI RUOTA - ACCESSORI VARI																										
	VGBP Volantino per ghiera fissaggio ruota	802260682		-	-	-	-	-	0	-	0	-	0	-	0	-	0	-	0	-	0	0	0	0		
	Kit 2 manopole girevoli	8-21100291		-	-	-	-	-	0	-	0	-	0	-	0	-	0	-	0	-	0	0	0	0		
	CBG Calotta per bloccaggio cerchi in lega Ø 210	802459564		0	0	0	0	0	0	0	0	0	0	0	0	0	0	0	0	0	0	0	0	0		
	OR ANELLO ELASTICO IN GOMMA	462817																								

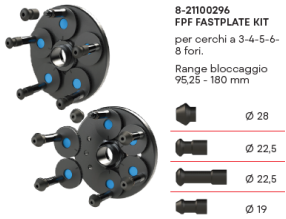
ACCESSORI EQUILIBRATICI A BANCO PER AUTO E MOTO

Immagine	Descrizione	Codice	EYE-LIGHT PLUS	EM9980 C PLUS	EM9780 C PLUS	EM9780 PLUS LINE	EM9680 C PLUS TOUCHSCREEN	EM9680 PLUS TOUCHSCREEN	EM9680 C PLUS	EM9680 PLUS	EM9650 C PLUS	EM9650 PLUS	EM9380 C / TOUCHSCREEN	EM9380 / TOUCHSCREEN	EM9350 C	EM9350	EM9280 C	EM9280	EM9250 C PREMIUM	EM9250 PREMIUM	EM9250 PROFESSIONAL	EM9250 BASIC	EM9250 BASIC BIKE LINE
	QLN Ghiera rapida pneumatica Quick Lock. Ghiera installabile su tutti i modelli con mozzo Ø 40 mm filettato. Accessoriato con pistola ad aria per bloccaggio	8-21100095	-	-	-	-	-	○	-	○	-	○	-	○	-	○	-	○	-	○	○	○	○
FLANGE DI BLOCCAGGIO RUOTE CON FORO CENTRALE																							
<p>per cerchi a 5 fori. Range bloccaggio 95,25 - 180 mm</p> <ul style="list-style-type: none"> Ø 28 Ø 22,5 Ø 22,5 Ø 19 	PFF FASTPLATE 5 per cerchi a 5 fori. Range bloccaggio 95,25 ÷ 180 mm 3-05125 INGRANAGGIO PLANETARIO 3-05126 PERNO A PRESSIONE B Ø28 L:25MM 3-05127 PERNO A PRESSIONE C Ø22,5 L:40MM 3-05128 PERNO A PRESSIONE C Ø22,5 L:65MM 3-05129 PERNO A PRESSIONE E Ø19 L:40MM	8-21100294	○	○	○	○	○	○	○	○	○	○	○	○	○	○	○	○	○	○	○	○	○
<p>per cerchi a 3-4-6-8 fori. Range bloccaggio 95,25 - 180 mm</p> <ul style="list-style-type: none"> Ø 28 Ø 22,5 Ø 22,5 Ø 19 	PFF FASTPLATE 3-4-6-8 per cerchi a 3-4-6-8 fori. Range bloccaggio 95,25 ÷ 180 mm 3-05125 INGRANAGGIO PLANETARIO 3-05126 PERNO A PRESSIONE B Ø28 L:25MM 3-05127 PERNO A PRESSIONE C Ø22,5 L:40MM 3-05128 PERNO A PRESSIONE C Ø22,5 L:65MM 3-05129 PERNO A PRESSIONE E Ø19 L:40MM	8-21100295	○	○	○	○	○	○	○	○	○	○	○	○	○	○	○	○	○	○	○	○	○

ACCESSORI EQUILIBRATRICI A BANCO PER AUTO E MOTO

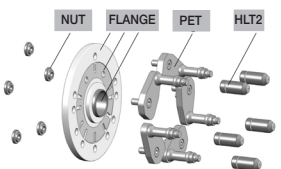
Immagine	Descrizione	Codice	EYE-LIGHT PLUS	EM9980 C PLUS	EM9780 C PLUS	EM9780 PLUS LINE	EM9680 C PLUS TOUCHSCREEN	EM9680 PLUS TOUCHSCREEN	EM9680 C PLUS	EM9680 PLUS	EM9650 C PLUS	EM9650 PLUS	EM9380 C / TOUCHSCREEN	EM9380 / TOUCHSCREEN	EM9350 C	EM9350	EM9280 C	EM9280	EM9250 C PREMIUM	EM9250 PREMIUM	EM9250 PROFESSIONAL	EM9250 BASIC	EM9250 BASIC BIKE LINE						
 <p>8-21100296 PFF FASTPLATE KIT per cerchi a 3-4-5-6-8 fori. Range bloccaggio 95,25 - 180 mm</p> <ul style="list-style-type: none">  Ø 28  Ø 22,5  Ø 22,5  Ø 19 	<p>PFF FASTPLATE KIT per cerchi a 3-4-5-6-8 fori. (contiene i kit 8-21100294 e 8-21100295) Range bloccaggio 95,25 ÷ 180 mm</p> <p>3-05125 INGRANAGGIO PLANETARIO 3-05126 PERNO A PRESSIONE B Ø28 L:25MM 3-05127 PERNO A PRESSIONE C Ø22,5 L:40MM 3-05128 PERNO A PRESSIONE C Ø22,5 L:65MM 3-05129 PERNO A PRESSIONE E Ø19 L:40MM</p>	8-21100296	O	O	O	O	O	O	O	O	O	O	O	O	O	O	O	O	O	O	O	O	O						
	<p>PFF-C SLEEVE HANDLE Manicotto per equilibratrici a bloccaggio automatico. Si avvita direttamente alla FASTPLATE per lavorare più comodamente e velocemente</p>	8-21100297	O	O	O	O	-	O	-	O	-	O	-	O	-	O	-	O	-	-	-	-							
FLANGE DI BLOCCAGGIO RUOTE CON FORO CENTRALE																													
	<p>PFF-2 BMW Flangia universale per ruote con foro centrale (Ø 4x100/5x120/5x112)</p>	8-21100145	O	O	O	O	O	O	O	O	O	O	O	O	O	O	O	O	O	O	O	O							
 <p>NUT FLANGE PET HLT2</p>	<p>PFF Basic Kit flange universali per ruote con foro centrale Ø 40 mm.</p> <table border="1" data-bbox="414 1292 1064 1364"> <tr> <td>HLT2</td> <td>TAPPO Ø 22,5 L 58</td> <td>4-109127</td> </tr> <tr> <td>PET</td> <td>PETALO BASIC</td> <td>4-108097</td> </tr> </table>	HLT2	TAPPO Ø 22,5 L 58	4-109127	PET	PETALO BASIC	4-108097	8-21100152	O	O	O	O	O	O	O	O	O	O	O	O	O	O	O	O	O	O	O	O	O
HLT2	TAPPO Ø 22,5 L 58	4-109127																											
PET	PETALO BASIC	4-108097																											

ACCESSORI EQUILIBRATICI A BANCO PER AUTO E MOTO

Immagine	Descrizione	Codice	EYE-LIGHT PLUS	EM9980 C PLUS	EM9780 C PLUS	EM9780 PLUS LINE	EM9580 C PLUS TOUCHSCREEN	EM9580 PLUS TOUCHSCREEN	EM9580 C PLUS	EM9580 PLUS	EM9550 C PLUS	EM9550 PLUS	EM9380 C / TOUCHSCREEN	EM9380 / TOUCHSCREEN	EM9350 C	EM9350	EM9280 C	EM9280	EM9250 C PREMIUM	EM9250 PREMIUM	EM9250 PROFESSIONAL	EM9250 BASIC	EM9250 BASIC BIKELINE																		
FLANGE PER RUOTE CON E SENZA FORO CENTRALE																																									
	FRU-SA D.40 Flangia universale per tutte le ruote con e senza foro centrale	8-21100091	○	○	○	○	○	○	○	○	○	○	○	○	○	○	○	○	○	○	○	○	○																		
	<table border="1"> <tr> <td>FT1</td> <td>BIELLA CON PERNO</td> <td>2401415</td> </tr> <tr> <td>DEB</td> <td>DADO BIFRONTI FISSAGGIO RUOTE</td> <td>321878</td> </tr> <tr> <td>CHT6</td> <td>CHIAVE ESAGONALE A T CH 6</td> <td>4-105877</td> </tr> <tr> <td>RFS</td> <td>RILEVATORE INTERASSE FORI</td> <td>441286</td> </tr> <tr> <td>CEP</td> <td>CHIAVE ESAGONALE A PIPA CH 22</td> <td>426517</td> </tr> <tr> <td>CHI 6</td> <td>CHIAVE ESAGONALE CH6</td> <td>600906</td> </tr> </table>	FT1	BIELLA CON PERNO	2401415	DEB	DADO BIFRONTI FISSAGGIO RUOTE	321878	CHT6	CHIAVE ESAGONALE A T CH 6	4-105877	RFS	RILEVATORE INTERASSE FORI	441286	CEP	CHIAVE ESAGONALE A PIPA CH 22	426517	CHI 6	CHIAVE ESAGONALE CH6	600906																						
	FT1	BIELLA CON PERNO	2401415																																						
	DEB	DADO BIFRONTI FISSAGGIO RUOTE	321878																																						
	CHT6	CHIAVE ESAGONALE A T CH 6	4-105877																																						
	RFS	RILEVATORE INTERASSE FORI	441286																																						
CEP	CHIAVE ESAGONALE A PIPA CH 22	426517																																							
CHI 6	CHIAVE ESAGONALE CH6	600906																																							
FLANGE PER RUOTE CON E SENZA FORO CENTRALE																																									
	BVFF Set di cinque boccole per un preciso centraggio su flangia FRU	8-21100092	○	○	○	○	○	○	○	○	○	○	○	○	○	○	○	○	○	○	○	○	○																		
	<table border="1"> <tr> <td>BF1</td> <td>BOCCOLA Ø 55 PEUGEOT</td> <td>4-105110</td> </tr> <tr> <td>BF2</td> <td>BOCCOLA Ø 58,1 FIAT RITMO E CITRÖEN CX/ EVASION, PEUGEOT 806</td> <td>4-105174</td> </tr> <tr> <td>BF3</td> <td>BOCCOLA Ø 60,1 RENAULT</td> <td>4-105175</td> </tr> <tr> <td>BF4</td> <td>BOCCOLA Ø 65 PEUGEOT, CITRÖEN</td> <td>4-105176</td> </tr> <tr> <td>BF5</td> <td>BOCCOLA Ø 57 BMW,VW, AUDI, SEAT</td> <td>4-106570</td> </tr> </table>	BF1	BOCCOLA Ø 55 PEUGEOT	4-105110	BF2	BOCCOLA Ø 58,1 FIAT RITMO E CITRÖEN CX/ EVASION, PEUGEOT 806	4-105174	BF3	BOCCOLA Ø 60,1 RENAULT	4-105175	BF4	BOCCOLA Ø 65 PEUGEOT, CITRÖEN	4-105176	BF5	BOCCOLA Ø 57 BMW,VW, AUDI, SEAT	4-106570																									
	BF1	BOCCOLA Ø 55 PEUGEOT	4-105110																																						
	BF2	BOCCOLA Ø 58,1 FIAT RITMO E CITRÖEN CX/ EVASION, PEUGEOT 806	4-105174																																						
	BF3	BOCCOLA Ø 60,1 RENAULT	4-105175																																						
	BF4	BOCCOLA Ø 65 PEUGEOT, CITRÖEN	4-105176																																						
BF5	BOCCOLA Ø 57 BMW,VW, AUDI, SEAT	4-106570																																							
FLANGE PER RUOTE CON E SENZA FORO CENTRALE																																									
	Disco di fissaggio boccole BVFF per flangia FRU-SA per equilibratrici a bloccaggio manuale	8-21100207	-	-	-	○	-	○	-	○	-	○	-	○	-	○	-	○	-	○	○	○	○																		

ACCESSORI EQUILIBRATICI A BANCO PER AUTO E MOTO

Immagine	Descrizione	Codice	EYE-LIGHT PLUS	EM9980 C PLUS	EM9780 C PLUS	EM9780 PLUS LINE	EM9580 C PLUS TOUCHSCREEN	EM9580 PLUS TOUCHSCREEN	EM9580 C PLUS	EM9580 PLUS	EM9550 C PLUS	EM9550 PLUS	EM9380 C / TOUCHSCREEN	EM9380 / TOUCHSCREEN	EM9350 C	EM9350	EM9280 C	EM9280	EM9250 C PREMIUM	EM9250 PREMIUM	EM9250 PROFESSIONAL	EM9250 BASIC	EM9250 BASIC BIKELINE
	Disco di bloccaggio flangia autocentrante per equilibratrici con bloccaggio automatico	8-21100208	○	○	○	-	○	-	○	-	○	-	○	-	○	-	○	-	○	-	-	-	-
	BCO Set di cinque rondelle coniche da utilizzare con DCL e DEB in caso di fori con ø maggiore di 21 mm	802321387	○	○	○	○	○	○	○	○	○	○	○	○	○	○	○	○	○	○	○	○	○
	DCL Set di cinque dadi conici per ruote in lega con flangia FRU-SA	802322075	○	○	○	○	○	○	○	○	○	○	○	○	○	○	○	○	○	○	○	○	○
	DMS Set di cinque dadi sferici per ruote in lega con flangia FRU-SA	802322076	○	○	○	○	○	○	○	○	○	○	○	○	○	○	○	○	○	○	○	○	○
	DC5 Set di cinque dadi speciali per Citroen C5	802262700	○	○	○	○	○	○	○	○	○	○	○	○	○	○	○	○	○	○	○	○	○

ACCESSORI EQUILIBRATICI A BANCO PER AUTO E MOTO

Immagine	Descrizione	Codice	EYE-LIGHT PLUS	EM9980 C PLUS	EM9780 C PLUS	EM9780 PLUS LINE	EM9580 C PLUS TOUCHSCREEN	EM9580 PLUS TOUCHSCREEN	EM9580 C PLUS	EM9580 PLUS	EM9550 C PLUS	EM9550 PLUS	EM9380 C / TOUCHSCREEN	EM9380 / TOUCHSCREEN	EM9350 C	EM9350	EM9280 C	EM9280	EM9250 C PREMIUM	EM9250 PREMIUM	EM9250 PROFESSIONAL	EM9250 BASIC	EM9250 BASIC BIKELINE
	SDR Set di cinque dadi per il fissaggio rapido ruote BC - BOCCOLA CONICA 431481 BOS - BOCCOLA SFERICA 431482 VF - VITE FISSAGGIO RAPIDO 431480	802231479	○	○	○	○	○	○	○	○	○	○	○	○	○	○	○	○	○	○	○	○	○
SISTEMI DI CALIBRAZIONE E ASSISTENZA TECNICA																							
	BLCK-1 calibratore per sensori laser per EyeLight Plus, EM9980-C Plus, EM9970 Plus (per centri di assistenza tecnica ed installatori)	8-21120001	○	○	○	○	-	-	-	-	-	-	-	-	-	-	-	-	-	-	-	-	-
	RS232 cavo seriale per aggiornare il firmware della scheda del pc (mbu-mbe-seb)	8-21100224	○	○	○	○	○	○	○	○	○	○	○	○	○	○	○	○	○	○	○	○	○
	Adattatore USB-RS232	8-21100226	○	○	○	○	○	○	○	○	○	○	○	○	○	○	○	○	○	○	○	○	○
	SLUG peso campione per calibrazione	8-21100221	■	■	■	■	■	■	■	■	■	■	■	■	■	■	■	■	■	■	■	■	■
	Kit utensili meccanici	8-21100197	○	○	○	○	○	○	○	○	○	○	○	○	○	○	○	○	○	○	○	○	○

ACCESSORI EQUILIBRATRICI A BANCO PER MOTO

ACCESSORI DI CENTRAGGIO E BLOCCAGGIO PER RUOTE DA MOTO

Nella gamma degli accessori per equilibratrici a banco è disponibile il nuovo BIKE UNIVERSAL KIT con diversi moduli aggiuntivi per il centraggio e l'equilibratura dinamica delle ruote da moto.

Di facile installazione e veloce utilizzo è ideale per le piccole ruote da scooter fino alle grandi off-road da 21"; senza tralasciare le larghe tipo chopper e quelle su monobraccio senza cuscinetti. Risultati di equilibratura eccellenti!

Universale per tutte le equilibratrici a listino a bloccaggio manuale ed automatico.

SCHEMA DI UTILIZZO

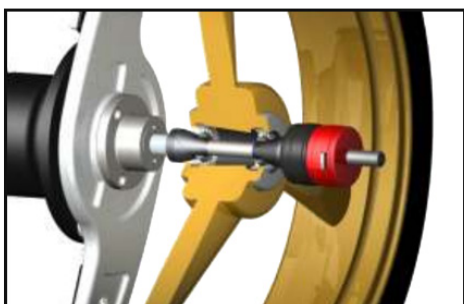

Albero con coni di centraggio

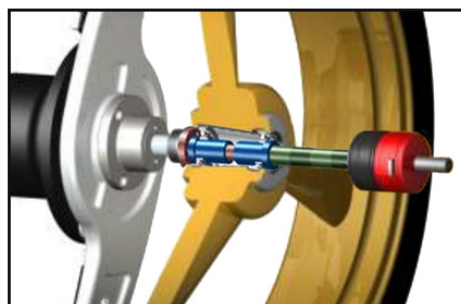

Albero con bussole di centraggio

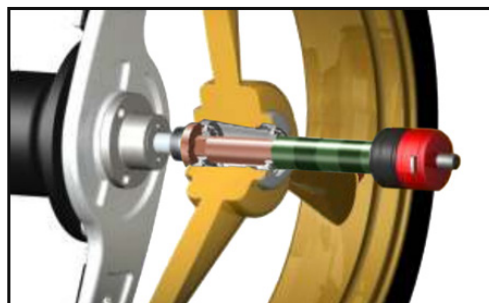

Albero della moto con lo stesso diametro del cuscinetto flottante



Albero con kit speciale di centraggio

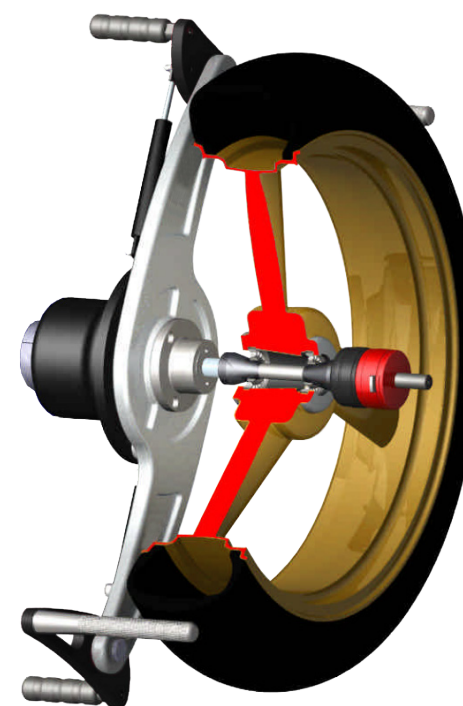

ACCESSORI EQUILIBRATICI A BANCO PER MOTOCICLI

Immagine	Descrizione	Codice	EYE-LIGHT PLUS	EM9980 C PLUS	EM9780 C PLUS	EM9780 PLUS LINE	EM9680 C PLUS TOUCHSCREEN	EM9680 PLUS TOUCHSCREEN	EM9580 C PLUS	EM9680 PLUS	EM9550 C PLUS	EM9650 PLUS	EM9380 C / TOUCHSCREEN	EM9380 / TOUCHSCREEN	EM9350 C	EM9350	EM9280 C	EM9280	EM9250 C PREMIUM	EM9250 PREMIUM	EM9250 PROFESSIONAL	EM9250 BASIC	EM9250 BASIC BIKELINE		
ACCESSORI STANDARD MOTO																									
	BIKE UNIVERSAL KIT	8-21120012	O	O	O	O	O	O	O	O	O	O	O	O	O	O	O	O	O	O	O	O	■		
	ATTREZZATURA BASE PER POTER EQUILIBRARE RUOTE DA MOTO E SCOOTER. ALBERO Ø 14 MM. PROLUNGA RILEVATORE NON INCLUSA																								
	1	GRUPPO TRASCINATORE	3-03408																						
	2	MANDRINO CILINDRICO	3-03409																						
	3	VITE TCEI M 6X14	3-03410																						
	4	CHIAVE CH 50	3-03411																						
	5	ALBERO DI CENTRAGGIO D. 14 MM	3-03412																						
	6	CONO CENTRAGGIO 15÷30 MM	3-03413																						
	7	CONO CENTRAGGIO 16÷45 MM (SCOOTER)	3-03414																						
	8	QUICK FIX PER ALBERO D. 14 MM	3-03415																						
9	PANNELLO A MURO	3-03416																							
10	DISTANZIALE CORTO	3-03417																							
11	GHIERA ZIGRINATA M 14	3-03418																							
12	CHIAVE ESAGONALE A BRUGOLA CH4	3-03419																							
13	BUSSOLA DI CENTRAGGIO D. 15 MM	3-03420																							
14	BUSSOLA DI CENTRAGGIO D. 17 MM	3-03421																							
15	BUSSOLA DI CENTRAGGIO D. 20 MM	3-03422																							
16	BUSSOLA DI CENTRAGGIO PIAGGIO	3-03423																							
17	CONO DI PRESSIONE BMW / HONDA	3-03407																							

ACCESSORI EQUILIBRATICI A BANCO PER MOTOCICLI

Immagine	Descrizione	Codice	EYE-LIGHT PLUS	EM9980 C PLUS	EM9780 C PLUS	EM9780 PLUS LINE	EM9580 C PLUS TOUCHSCREEN	EM9580 PLUS TOUCHSCREEN	EM9580 C PLUS	EM9580 PLUS	EM9550 C PLUS	EM9550 PLUS	EM9380 C / TOUCHSCREEN	EM9380 / TOUCHSCREEN	EM9350 C	EM9350	EM9280 C	EM9280	EM9250 C PREMIUM	EM9250 PREMIUM	EM9250 PROFESSIONAL	EM9250 BASIC	EM9250 BASIC BIKELINE											
	PRA3 Prolunga rilevatore per ruote moto. Per modelli con clip	8-21100116	-	-	-	-	○	○	○	○	○	○	○	○	○	○	○	○	○	○	○	○	○											
	KIT ALBERO Ø10MM PER IL CENTRAGGIO DI RUOTE DA MOTO E SCOOTER L = 230 MM CON CUSCINETTI DA Ø 10 ÷ 20 MM (AD EVENTUALE INTEGRAZIONE DEL COD. 8-21120012.)	8-21100257	○	○	○	○	○	○	○	○	○	○	○	○	○	○	○	○	○	○	○	○	○											
	<table border="1"> <tr> <td>1</td> <td>SHAFT Ø 10 MM</td> <td>3-03864</td> </tr> <tr> <td>2</td> <td>SPACER</td> <td>3-03865</td> </tr> <tr> <td>3</td> <td>CENTERING CONE D. 12÷20 MM</td> <td>3-03866</td> </tr> <tr> <td>4</td> <td>RING NUT M 10</td> <td>3-03867</td> </tr> </table>	1	SHAFT Ø 10 MM	3-03864	2	SPACER	3-03865	3	CENTERING CONE D. 12÷20 MM	3-03866	4	RING NUT M 10	3-03867																					
1	SHAFT Ø 10 MM	3-03864																																
2	SPACER	3-03865																																
3	CENTERING CONE D. 12÷20 MM	3-03866																																
4	RING NUT M 10	3-03867																																

ACCESSORI EQUILIBRATICI A BANCO PER MOTOCICLI

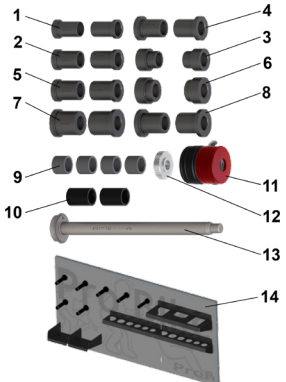
Immagine	Descrizione	Codice	EYE-LIGHT PLUS	EM9980 C PLUS	EM9780 C PLUS	EM9780 PLUS LINE	EM9580 C PLUS TOUCHSCREEN	EM9580 PLUS TOUCHSCREEN	EM9580 C PLUS	EM9580 PLUS	EM9560 C PLUS	EM9560 PLUS	EM9380 C / TOUCHSCREEN	EM9380 / TOUCHSCREEN	EM9360 C	EM9360	EM9280 C	EM9280	EM9260 C PREMIUM	EM9260 PREMIUM	EM9260 PROFESSIONAL	EM9260 BASIC	EM9260 BASIC BIKELINE	
ACCESSORI STANDARD MOTO																								
	PRA4 Prolunga rilevatore per ruote moto. Per modelli senza clip	8-21100155	-	-	-	-	-	-	-	-	-	-	0	0	0	0	0	0	0	0	0	0	0	■
	BIKE UPGRADE KIT 19 MODULO AGGIUNTIVO AL BIKE UNIVERSAL KIT	8-21120013	0	0	0	0	0	0	0	0	0	0	0	0	0	0	0	0	0	0	0	0	0	0
	1	BUSSOLA DI CENTRAGGIO D. 22 MM	3-03383																					
	2	BUSSOLA DI CENTRAGGIO D. 25,4 MM	3-03384																					
	3	BUSSOLA DI CENTRAGGIO D. 25 MM	3-03385																					
	4	BUSSOLA DI CENTRAGGIO D. 26 MM	3-03386																					
	5	BUSSOLA DI CENTRAGGIO D. 28 MM	3-03387																					
	6	BUSSOLA DI CENTRAGGIO D. 32 MM	3-03388																					
	7	BUSSOLA DI CENTRAGGIO D. 35 MM	3-03389																					
	8	BUSSOLA DI CENTRAGGIO D. 30 MM	3-03390																					
	9	DISTANZIALE CORTO D. 20 MM	3-03391																					
	10	BOCCOLA DI PRESSIONE HARLEY D.	3-03392																					
	11	QUICK FIX PER ALBERO D. 19	3-03393																					
	12	GHIERA ZIGRINATA M 14	3-03418																					
	13	ALBERO DI CENTRAGGIO D. 19 MM	3-03396																					
	14	PANNELLO A MURO	3-03395																					

ACCESSORI EQUILIBRATICI A BANCO PER AUTO E MOTO

Immagine	Descrizione	Codice	EYE-LIGHT PLUS	EM9980 C PLUS	EM9780 C PLUS	EM9780 PLUS LINE	EM9680 C PLUS TOUCHSCREEN	EM9680 PLUS TOUCHSCREEN	EM9580 C PLUS	EM9680 PLUS	EM9550 C PLUS	EM9650 PLUS	EM9380 C / TOUCHSCREEN	EM9380 / TOUCHSCREEN	EM9350 C	EM9350	EM9280 C	EM9280	EM9250 C PREMIUM	EM9250 PREMIUM	EM9250 PROFESSIONAL	EM9250 BASIC	EM9250 BASIC BIKELINE	
ACCESSORI STANDARD MOTO																								
	BIKE MONOLEVER KIT 19	8-21120014	○	○	○	○	○	○	○	○	○	○	○	○	○	○	○	○	○	○	○	○	○	
	Modulo aggiuntivo al BIKE UPGRADE KIT per ruote da moto con monobraccio																							
	1	BUSSOLA DI CENTRAGGIO DUCATI	3-03397																					
	2	BUSSOLA HONDA / MV AUGUSTA	3-03398																					
	3	BUSSOLA DI CENTRAGGIO HONDA	3-03399																					
	4	BUSSOLA APRILIA / BMW / DUCATI	3-03400																					
	5	BUSSOLA TRIUMPH / HONDA VFR1200	3-03401																					
	6	ADATTATORE	3-03402																					
	7	BUSSOLA DI CENTRAGGIO TRIUMPH	3-03403																					
	8	DISTANZIALE LUNGO	3-03404																					
	9	DISCO DI CENTRAGGIO BMW II	3-03405																					
10	DISCO DI CENTRAGGIO BMW I	3-03406																						
	Albero moto Ø14mm extra-lungo 318mm, ad eventuale integrazione del cod. 8-21120012	8-21120016	○	○	○	○	○	○	○	○	○	○	○	○	○	○	○	○	○	○	○	○	○	
	Albero moto Ø19mm extra-lungo 365mm, ad eventuale integrazione del cod. 8-21120013	8-21120017	○	○	○	○	○	○	○	○	○	○	○	○	○	○	○	○	○	○	○	○	○	

EM 9050 SPACESAVER



DOTAZIONE



Codice	Alimentazione	Descrizione
0-21109051/16	100-230V/1Ph/50-60Hz	EM 9050 SPACESAVER - Hand Spin Equilibratrice compatta e leggera, ideale per il servizio mobile e per officine con spazio limitato. Rilevamento automatico delle dimensioni ruota SmartArm 28". Freno di stazionamento a leva. Versione a lancio manuale.
0-21109050/16	200-230V/1Ph/50-60Hz	EM 9050 SPACESAVER - Motorized Spin Equilibratrice compatta e leggera, ideale per il servizio mobile e per officine con spazio limitato. Rilevamento automatico delle dimensioni ruota SmartArm 28". Freno di stazionamento a leva. Versione a lancio motorizzato azionato a leva.

EM 9050 - TILT UP - HAND SPIN



DOTAZIONE



Codice	Alimentazione	Descrizione
0-21109052/16	100-230V/1Ph/50-60Hz	EM 9050 - TILT UP Hand Spin Equilibratrice compatta e leggera, versione speciale per il servizio mobile e per officine con spazio limitato, ideale per lavorare all'interno del furgone grazie alla possibilità di ribaltare il gruppo di misura in posizione verticale. Rilevamento automatico delle dimensioni ruota SmartArm 28". Freno di stazionamento a leva. Versione a lancio manuale.

EM 9050 - SLIDE - MOTORIZED SPIN



DOTAZIONE

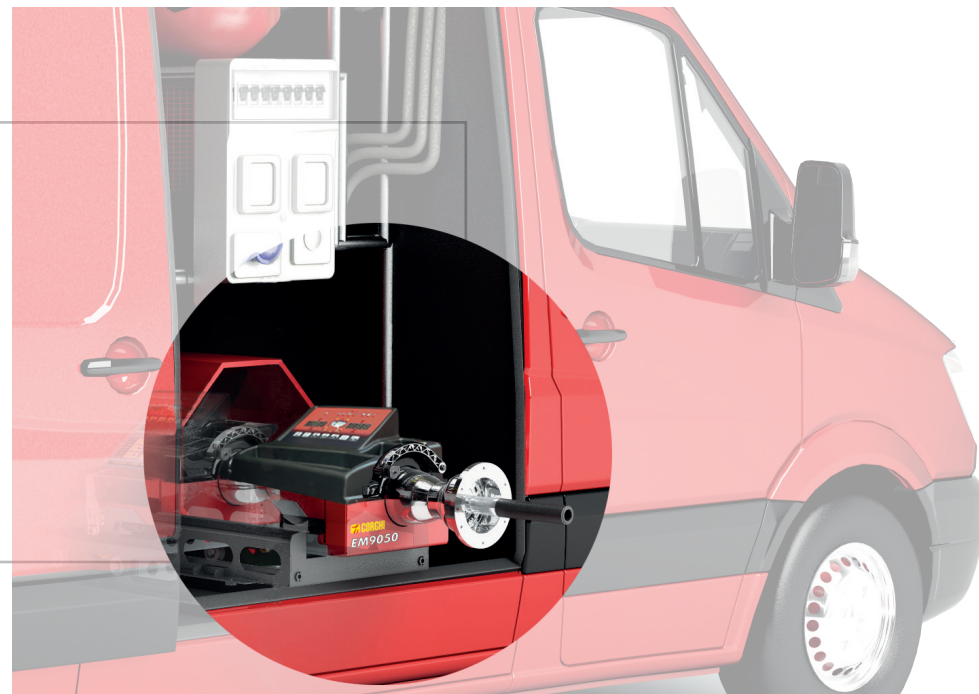

Codice	Alimentazione	Descrizione
0-21109053/16	200-230V/1Ph/50-60Hz	EM 9050 - SLIDE - Motorized Spin Equilibratrice compatta e leggera, versione speciale per il servizio mobile, si estrae dal portellone laterale e permette di lavorare comodamente all'esterno del furgone. Rilevamento automatico delle dimensioni ruota SmartArm 28". Freno di stazionamento a leva. Versione a lancio motorizzato azionato a leva.

EM 9050 WORKBENCH



DOTAZIONE



Ø 42÷103,5 mm



PER VERSIONE A
LANCIO MANUALE



PER VERSIONE
A MOTORE



Codice	Alimentazione	Descrizione
0-21109057/16	100÷230/1Ph/50-60Hz	EM9050 WORKBENCH - Hand Spin. Equilibratrice estremamente compatta. Si fissa ad un banco da lavoro. Per hobbisti, piccole officine o per servizio mobile. Rilevamento automatico delle dimensioni ruota SmartArm 28". Freno di stazionamento a leva. Versione a lancio manuale.
0-21109056/16	200÷230/1Ph/50-60Hz	EM9050 WORKBENCH - Motorized Spin. Equilibratrice estremamente compatta. Si fissa ad un banco da lavoro. Per hobbisti, piccole officine o per servizio mobile. Rilevamento automatico delle dimensioni ruota SmartArm 28". Freno di stazionamento a leva. Versione a lancio motorizzato azionato a leva.

ACCESSORI EQUILBRATRICI PER IL SERVIZIO MOBILE

Immagine	Descrizione	Codice		EM 9050 HS	EM 9050 Motor	EM 9050 Tilt	EM 9050 Slide	EM 9050 WB HS	EM 9050 WB Motor
	PL - piede di stabilizzazione per evitare il fissaggio a terra; disponibile in rosso (/16) e in grigio (/90) (solo per EM9050, EM9050 HS, EM9050 MOT e EM9050 TILT)	8-21101100/XX		O	O	O	-	-	-
	Trolley Kit per uno spostamento più agevole (solo per EM9050, EM9050 HS, EM9050 MOT e EM9050 TILT)	8-21101200		O	O	O	-	-	-
	AL12 - per il collegamento ad una fonte esterna a 12V (solo per versioni EM9050 Hand Spin)	8-21101000		O	-	O	-	O	-
	TILT kit - kit di trasformazione in versione TILT, ideale per lavorare all'interno del furgone grazie alla possibilità di ribaltare il gruppo di misura in posizione verticale (solo per versioni EM9050 HS, EM9050 MOT)	8-21101300		O	O	-	-	-	-
	KFTU Kit - set di fisher e staffe per fissare l'equilibratrice al pavimento (incluso nelle EM9050 Hand Spind, EM9050 Motorized Spin, EM9050 TILT UP)	8-21101010		■	■	■	-	-	-

ACCESSORI EQUILIBRATICI PER IL SERVIZIO MOBILE

Immagine	Descrizione	Codice		EM 9050 HS	EM 9050 Motor	EM 9050 Tilt	EM 9050 Slide	EM 9050 WB HS	EM 9050 WB Motor												
	ARF - Kit coni centraggio fuoristrada Ø 100 ÷118,5 mm, Ø 100 ÷129,5 mm CGF - CONO FUORISTRADA (FURGONI) 4-103186 PCF1 - PROTEZIONE PER CENTRAGGIO CERCHI IN LEGA 4-115868 CF1 - CALOTTA FISSAGGIO RUOTA 4-115863	8-21100080		○	○	○	○	○	○												
	DX/CBF Accessorio di centraggio per furgoni e fuoristrada con foro centrale Ø 117÷173 mm. <table border="1"> <tr> <td>DX1</td> <td>DISTANZIALE</td> <td>4-107426</td> </tr> <tr> <td>CF1</td> <td>CONO FURGONI Ø 117÷147 MM</td> <td>4-107423</td> </tr> <tr> <td>CF2</td> <td>CONO FURGONI 143÷173 MM</td> <td>4-107424</td> </tr> </table>	DX1	DISTANZIALE	4-107426	CF1	CONO FURGONI Ø 117÷147 MM	4-107423	CF2	CONO FURGONI 143÷173 MM	4-107424	8-21100141		○	○	○	○	○	○			
DX1	DISTANZIALE	4-107426																			
CF1	CONO FURGONI Ø 117÷147 MM	4-107423																			
CF2	CONO FURGONI 143÷173 MM	4-107424																			
	SBC Set di sei boccole di centraggio. <table border="1"> <tr> <td>B1 AUDI, BMW, CHRYSLER, OPEL, ROVER, SEAT, VW, DAEWOO, GALAXY (FORD), LOTUS, BRITISH-LEYLAND, SMART (MERCEDES), SKODA</td> <td>4-105075</td> </tr> <tr> <td>B2 CITRÖEN, HYUNDAI, LANCIA, MASERATI, MAZDA, MERCEDES, MITSUBISHI, NISSAN, OPEL, PEUGEOT, SAAB, VOLVO.</td> <td>4-105076</td> </tr> <tr> <td>B3 BMW, JAGUAR, ASTON MARTIN.</td> <td>4-105077</td> </tr> <tr> <td>B4 FORD, HONDA, ROVER</td> <td>4-105078</td> </tr> <tr> <td>B5 AUTOBIANCHI, ALFA ROMEO, CITRÖEN, FIAT, LADA, LANCIA, JALBOT, BITURBO (MASERATI), MAZDA, NISSAN, PEUGEOT, PORSCHE, RENAULT, 2600-3500 SERIE (ROVER), SEAT =>90, SKODA, TOYOTA.</td> <td>4-105079</td> </tr> <tr> <td>B7 CITRÖEN, DAIHATSU, HONDA, KIA, MAZDA, MITSUBISHI, PEUGEOT, ROVER, SUBARU, TOYOTA, AGILA (OPEL), SUZUKI, HYUDAY.</td> <td>4-105080</td> </tr> </table>	B1 AUDI, BMW, CHRYSLER, OPEL, ROVER, SEAT, VW, DAEWOO, GALAXY (FORD), LOTUS, BRITISH-LEYLAND, SMART (MERCEDES), SKODA	4-105075	B2 CITRÖEN, HYUNDAI, LANCIA, MASERATI, MAZDA, MERCEDES, MITSUBISHI, NISSAN, OPEL, PEUGEOT, SAAB, VOLVO.	4-105076	B3 BMW, JAGUAR, ASTON MARTIN.	4-105077	B4 FORD, HONDA, ROVER	4-105078	B5 AUTOBIANCHI, ALFA ROMEO, CITRÖEN, FIAT, LADA, LANCIA, JALBOT, BITURBO (MASERATI), MAZDA, NISSAN, PEUGEOT, PORSCHE, RENAULT, 2600-3500 SERIE (ROVER), SEAT =>90, SKODA, TOYOTA.	4-105079	B7 CITRÖEN, DAIHATSU, HONDA, KIA, MAZDA, MITSUBISHI, PEUGEOT, ROVER, SUBARU, TOYOTA, AGILA (OPEL), SUZUKI, HYUDAY.	4-105080	8-21100082		○	○	○	○	○	○
B1 AUDI, BMW, CHRYSLER, OPEL, ROVER, SEAT, VW, DAEWOO, GALAXY (FORD), LOTUS, BRITISH-LEYLAND, SMART (MERCEDES), SKODA	4-105075																				
B2 CITRÖEN, HYUNDAI, LANCIA, MASERATI, MAZDA, MERCEDES, MITSUBISHI, NISSAN, OPEL, PEUGEOT, SAAB, VOLVO.	4-105076																				
B3 BMW, JAGUAR, ASTON MARTIN.	4-105077																				
B4 FORD, HONDA, ROVER	4-105078																				
B5 AUTOBIANCHI, ALFA ROMEO, CITRÖEN, FIAT, LADA, LANCIA, JALBOT, BITURBO (MASERATI), MAZDA, NISSAN, PEUGEOT, PORSCHE, RENAULT, 2600-3500 SERIE (ROVER), SEAT =>90, SKODA, TOYOTA.	4-105079																				
B7 CITRÖEN, DAIHATSU, HONDA, KIA, MAZDA, MITSUBISHI, PEUGEOT, ROVER, SUBARU, TOYOTA, AGILA (OPEL), SUZUKI, HYUDAY.	4-105080																				
	VGBP Volantino per ghiera fissaggio ruota	802260682		○	■	○	■	○	■												

ACCESSORI EQUILBRATRICI PER IL SERVIZIO MOBILE

Immagine	Descrizione	Codice		EM 9050 HS	EM 9050 Motor	EM 9050 Tilt	EM 9050 Slide	EM 9050 WB HS	EM 9050 WB Motor
	<p>KIT LASER BLADE puntatore laser integrato nel braccio rilevatore digitale interno, diametro/distanza per guidare l'operatore nella scelta dei piani interni del cerchio senza commettere errori e con estrema visibilità. Sistema Plug&Play dedicato.</p>	8-21120022		O	O	O	O	O	O

ET 1050 MOBILE TRUCK







DOTAZIONE



Codice	Alimentazione	Descrizione	
0-21101050/34	100÷230V/1ph/50-60Hz	ET1050 MOBILE TRUCK Hand spin Equilibratrice portatile per ruote da camion e autobus; dal peso contenuto e dalle dimensioni compatte; montabile su qualsiasi tipo di smontagomme da autocarro a mandrino; particolarmente adatta al servizio mobile e a chi ha poco spazio in officina.	
8-21101051		kit di personalizzazione ET1050 Mobile Truck obbligatorio	

ACCESSORI RACCOMANDATI PER ET 1050 MOBILE TRUCK

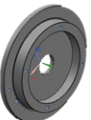
Immagine	Descrizione	Codice	
	ART40 - accessorio professionale di centraggio per ruote camion	8-21900220	
	GGR40 - kit di centraggio diam. 40 per ruote con foro centrale 183,5÷223 mm, cerchi da 17,5" a 19,5" (IVECO - MAN - DAF)	8-21100261	
	CAR MATE - kit centraggio e bloccaggio ruote Ø 42÷ 103,5 mm	8-21100278	
	Kit Trolley per supporto	8-21101052	
	DTMS - Adattatore per il montaggio degli accessori di centraggio camion, ART 40 EVO, KCT 40 EVO e ARV 40	8-21100267	

ET 1680 TRUCKLINE TOUCHSCREEN



STANDARD ACCESSORIES

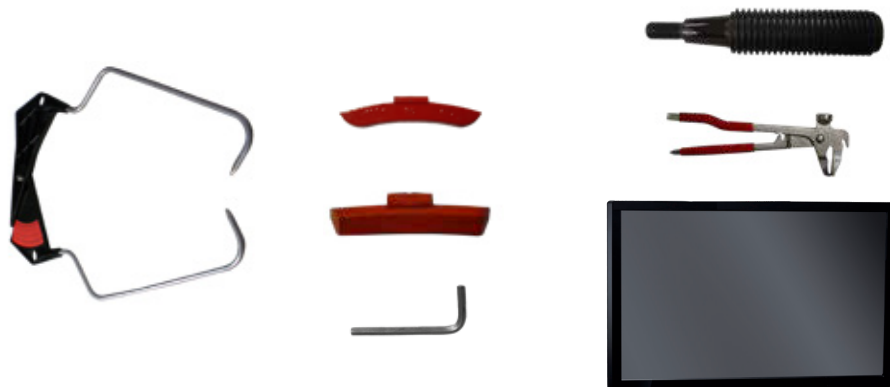

NEW!

Codice	Alimentazione	Descrizione
0-21101680/16	200-230V / 1PH / 50-60HZ	Equilibratrice avanzata touchscreen per ruote heavy-duty , sollevare e bilancia ruote fino a 52" di diametro e 300 kg di peso. Dotata del sistema SMART ARM PLUS, garantisce misurazioni rapide e precise grazie al Fast Selection Program (FSP) e agli indicatori LaserBlade e LaserLine Pro. Include una varietà di programmi, tra cui il sistema Weight Management Plus. Sensori SONAR opzionali la trasformano in uno strumento diagnostico avanzato, capace di rilevare e correggere difetti geometrici che causano vibrazioni non risolvibili con la bilanciatura tradizionale (AWD Sonar e Run-Out kit non inclusi).

ET 1650 TRUCKLINE



STANDARD ACCESSORIES



NEW!

Codice	Alimentazione	Descrizione
0-21101650/16	200-230V / 1PH / 50-60HZ	Equilibratrice digitale per ruote heavy-duty , solleva e bilancia ruote fino a 52" di diametro e 300 kg di peso. Dotata del sistema SMART ARM PLUS, garantisce misurazioni rapide e precise grazie al Fast Selection Program (FSP) e agli indicatori LaserBlade e LaserLine Pro. Facile da usare, l'equilibratrice offre una vasta gamma di programmi per soddisfare ogni esigenza, garantendo prestazioni eccellenti in tutte le condizioni (AWD Sonar non incluso).

ET 1450 TRUCKLINE



DOTAZIONE



cod.
802227308



Codice	Alimentazione	Descrizione	
0-21101450/16	200÷230V/1Ph/50-60Hz	ET1450 MO - Equilibratrici motorizzata e compatta per ruote da bus e camion, SmartArm 28", AWC, freno automatico a fine lancio, inverter Technology System, sollevatore ruota integrato.	
0-21101451/16	100÷230V/1Ph/50-60Hz	ET1450 HS - Equilibratrici compatta con lancio manuale per ruote da bus e camion, SmartArm 28", AWC, freno manuale, sollevatore ruota integrato.	

ET 88



DOTAZIONE



Codice	Alimentazione	Descrizione
2121110101/16	200-230V / 1Ph / 50-60Hz	ET88 Equilibratrice motorizzata per ruote da camion con acquisizione automatica dei dati; monitor, sollevatore ruota e protezione inclusi.

ET 77



DOTAZIONE



COD.
802227308

COD.
238304







Codice	Alimentazione	Descrizione
2123120101/16	200-230V / 1Ph / 50-60Hz	ET77 Equilibratrice a display LED, motorizzata per ruote da camion con acquisizione automatica dei dati, monitor, sollevatore ruota e protezione inclusi.



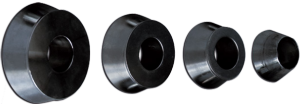

ACCESSORI EQUILIBRATICI A BANCO PER AUTOCARRI

immagine	Descrizione	Codice	ET1680	ET1650	ET1450 MO	ET1450 HS	ET88	ET77
CENTRAGGIO E BLOCCAGGIO RUOTA								
	KIT ART 40 EVO - Kit Adattatore Premium Heavy-Duty (10-8-6 fori)	8-21100269	○	○	○	○	-	-
	FAT 1	FLANGIA APPOGGIO PER CERCHI AUTOCARRO CON FORO Ø 160/176/200 MM	4-141439					
	FAT 2	FLANGIA APPOGGIO PER CERCHI AUTOCARRO CON FORO Ø 220/280 MM	4-141440					
	PT	PUNTALE PER CENTRAGGIO RUOTE AUTOCARRO CON FORI FISSAGGIO Ø 18-35 MM	5-125120					
	PMT	PUNTALE MAXI PER CENTRAGGIO RUOTE AUTOCARRO CON FORI FISSAGGIO Ø 28-47 MM	5-125119					
	MFE	MOZZO CON FLANGIA	5-125117					
	RFT	RILEVATORE FORI PER MISURA DISTANZA FORI FISSAGGIO RUOTE AUTOCARRO	5-125118					
	KCT40 EVO - Kit coni Heavy-Duty	8-21100268	○	○	○	○	-	-
	CT 161	CT161 D40 CONO MEDIO BIFRONTI Ø159 ÷180 / 198 ÷204 MM	4-141436					
	DTB 2	DBT 2 FLANGIA DISTANZIALE BIFRONTI PER APPOGGIO CERCHI AUTOCARRO	4-141437					
	CT 221	CT221 D40 CONO GRANDE BIFRONTI Ø220-281 MM	4-141438					
	ARV40 - Kit Adattatore Premium Medium&Light per veicoli commerciali (6-fori)	8-21100270	○	○	○	○	-	-
	FAT 3	FAT3 FLANGIA APPOGGIO PER CERCHI AUTOCARRO CON FORO Ø 129/141 MM	4-141446					
	FAT 4	FAT4 FLANGIA APPOGGIO PER CERCHI AUTOCARRO CON FORO Ø 137/160 MM	4-141445					
	RFT	RFT RILEVATORE FORI PER MISURA DISTANZA FORI FISSAGGIO RUOTE AUTOCARRO	5-125118					
	PT	PUNTALE PER CENTRAGGIO RUOTE AUTOCARRO CON FORI FISSAGGIO Ø 18-35 MM	5-125120					
	FPF6	FPF6 D40 FLANGIA PER RUOTE CON 6 PUNTI DI FISSAGGIO 170 / 180 / 184,15 / 185 / 200 / 205 / 214,5 / 222,3 / 241,3/ 245 "	5-125122					

ACCESSORI EQUILIBRATICI A BANCO PER AUTOCARRI

immagine	Descrizione	Codice		ET1680	ET1650	ET1450 MO	ET1450 HS	ET188	ET77
CENTRAGGIO E BLOCCAGGIO RUOTA									
	GGR40 - kit di centraggio diam. 40 per ruote con foro centrale 183,5÷223 mm, cerchi da 17,5" a 19,5" (IVECO - MAN - DAF)	8-21100261		O	O	O	O	-	-
 DX1 CF1 CF2	DX/CFB Accessorio di centraggio per furgoni e fuoristrada con foro centrale Ø 117÷173 mm	8-21100141		O	O	O	O	-	-
	DX1 DISTANZIALE	4-107426							
	CF1 CONO FURGONI Ø 117÷147 MM	4-107423							
	CF2 CONO FURGONI 143÷173 MM	4-107424							
	ARU40 Ø42÷156 mm (1,65"÷6,14") - molla incassata inclusa	8-21900191		O	O	O	O	-	-
	CBG-2 Calotta fissaggio ruota grande (Ø 220 mm). Per ghiera rapide GTR40 EVO.	8-21100284		O	O	O	O	-	-
	GTR40 EVO PRO - Ghiera rapida di bloccaggio in acciaio Ø 40x4 mm	8-21100275		O	O	O	-	-	-



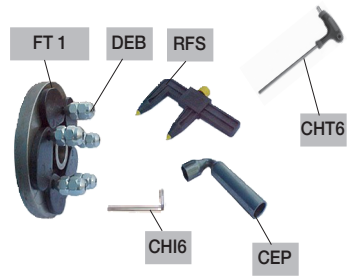

ACCESSORI EQUILIBRATICI A BANCO PER AUTOCARRI

immagine	Descrizione	Codice		ET1680	ET1650	ET1450 MO	ET1450 HS	ET188	ET77																	
CENTRAGGIO E BLOCCAGGIO RUOTA																										
	GTR40 EVO - Ghiera rapida di bloccaggio Ø 40x4 mm	8-21100276		O	O	O	-	-	-																	
	GTR40 EVO HS - Ghiera rapida di bloccaggio Ø 40x4 mm completa di manopole	8-21100279		-	-	-	O	-	-																	
	GTV40 - ghiera base di bloccaggio per ruote camion e auto	8-21900194		O	O	O	-	-	-																	
	GTM40 - Ghiera base di bloccaggio Ø 40x4 mm	8-21100272		-	-	-	O	-	-																	
	FRU-SA D.40 Flangia universale per tutte le ruote con e senza foro centrale	8-21100091		O	O	O	O	-	-																	
	<table border="1"> <tbody> <tr> <td>FRU SA</td> <td>FLANGIA FRU D. 40</td> <td>2401415</td> </tr> <tr> <td>DEB</td> <td>DADO BIFRONTI FISSAGGIO RUOTE</td> <td>321878</td> </tr> <tr> <td>CHT6</td> <td>CHIAVE ESAGONALE A T CH 6</td> <td>4-105877</td> </tr> <tr> <td>RFS</td> <td>RILEVATORE INTERASSE FORI</td> <td>2008157</td> </tr> <tr> <td>CEP</td> <td>CHIAVE ESAGONALE A PIPA CH 22</td> <td>426517</td> </tr> <tr> <td>CHI 6</td> <td>CHIAVE ESAGONALE CH6</td> <td>2-00906</td> </tr> </tbody> </table>	FRU SA	FLANGIA FRU D. 40	2401415	DEB	DADO BIFRONTI FISSAGGIO RUOTE	321878	CHT6	CHIAVE ESAGONALE A T CH 6	4-105877	RFS	RILEVATORE INTERASSE FORI	2008157	CEP	CHIAVE ESAGONALE A PIPA CH 22	426517	CHI 6	CHIAVE ESAGONALE CH6	2-00906							
FRU SA	FLANGIA FRU D. 40	2401415																								
DEB	DADO BIFRONTI FISSAGGIO RUOTE	321878																								
CHT6	CHIAVE ESAGONALE A T CH 6	4-105877																								
RFS	RILEVATORE INTERASSE FORI	2008157																								
CEP	CHIAVE ESAGONALE A PIPA CH 22	426517																								
CHI 6	CHIAVE ESAGONALE CH6	2-00906																								

ACCESSORI EQUILIBRATICI A BANCO PER AUTOCARRI

immagine	Descrizione	Codice	ET1680	ET1650	ET1450 MO	ET1450 HS	ET88	ET77																	
CENTRAGGIO E BLOCCAGGIO RUOTA																									
	TWS40 Distanziale ruote camion Ø 40 (30mm - 1.19")	8-21100290	○	○	○	○	-	-																	
	ART Accessorio professionale di centraggio per ruote camion	802239637	-	-	-	-	○	○																	
	<table border="1"> <tr> <td>FAT 1</td> <td>FLANGIA APPOGGIO PER CERCHI AUTOCARRO CON FORO Ø 160/176/200 MM</td> <td>339635</td> </tr> <tr> <td>FAT 2</td> <td>FLANGIA APPOGGIO PER CERCHI AUTOCARRO CON FORO Ø 220/280 MM</td> <td>339636</td> </tr> <tr> <td>PT</td> <td>PUNTALE PER CENTRAGGIO RUOTE AUTOCARRO CON FORI FISSAGGIO Ø 18-35 MM</td> <td>339668</td> </tr> <tr> <td>PMT</td> <td>PUNTALE MAXI PER CENTRAGGIO RUOTE AUTOCARRO CON FORI FISSAGGIO Ø 28-47 MM</td> <td>341818</td> </tr> <tr> <td>MFE</td> <td>MOZZO CON FLANGIA</td> <td>239655</td> </tr> <tr> <td>RFT</td> <td>RILEVATORE FORI PER MISURA DISTANZA FORI FISSAGGIO RUOTE AUTOCARRO</td> <td>245514</td> </tr> </table>	FAT 1	FLANGIA APPOGGIO PER CERCHI AUTOCARRO CON FORO Ø 160/176/200 MM	339635	FAT 2	FLANGIA APPOGGIO PER CERCHI AUTOCARRO CON FORO Ø 220/280 MM	339636	PT	PUNTALE PER CENTRAGGIO RUOTE AUTOCARRO CON FORI FISSAGGIO Ø 18-35 MM	339668	PMT	PUNTALE MAXI PER CENTRAGGIO RUOTE AUTOCARRO CON FORI FISSAGGIO Ø 28-47 MM	341818	MFE	MOZZO CON FLANGIA	239655	RFT	RILEVATORE FORI PER MISURA DISTANZA FORI FISSAGGIO RUOTE AUTOCARRO	245514						
FAT 1	FLANGIA APPOGGIO PER CERCHI AUTOCARRO CON FORO Ø 160/176/200 MM	339635																							
FAT 2	FLANGIA APPOGGIO PER CERCHI AUTOCARRO CON FORO Ø 220/280 MM	339636																							
PT	PUNTALE PER CENTRAGGIO RUOTE AUTOCARRO CON FORI FISSAGGIO Ø 18-35 MM	339668																							
PMT	PUNTALE MAXI PER CENTRAGGIO RUOTE AUTOCARRO CON FORI FISSAGGIO Ø 28-47 MM	341818																							
MFE	MOZZO CON FLANGIA	239655																							
RFT	RILEVATORE FORI PER MISURA DISTANZA FORI FISSAGGIO RUOTE AUTOCARRO	245514																							
	KCT Accessorio base di centraggio ruote camion	802245159	-	-	-	-	○	○																	
	<table border="1"> <tr> <td>DBT</td> <td>FLANGIA DISTANZIALE BIFRONTI PER APPOGGIO CERCHI AUTOCARRO</td> <td>345160</td> </tr> <tr> <td>CT 161</td> <td>CONO MEDIO BIFRONTI Ø159 ±180 / 198 ±204 MM</td> <td>345161</td> </tr> <tr> <td>CT 221</td> <td>CONO GRANDE BIFRONTI Ø220-281 MM</td> <td>345162</td> </tr> </table>	DBT	FLANGIA DISTANZIALE BIFRONTI PER APPOGGIO CERCHI AUTOCARRO	345160	CT 161	CONO MEDIO BIFRONTI Ø159 ±180 / 198 ±204 MM	345161	CT 221	CONO GRANDE BIFRONTI Ø220-281 MM	345162															
DBT	FLANGIA DISTANZIALE BIFRONTI PER APPOGGIO CERCHI AUTOCARRO	345160																							
CT 161	CONO MEDIO BIFRONTI Ø159 ±180 / 198 ±204 MM	345161																							
CT 221	CONO GRANDE BIFRONTI Ø220-281 MM	345162																							
	ARFT Accessorio di centraggio per ruote fuoristrada e furgoni	802247716	-	-	-	-	○	○																	
	<table border="1"> <tr> <td>DPT</td> <td>FLANGIA DISTANZIALE PER APPOGGIO CERCHI FURGONI</td> <td>341843</td> </tr> <tr> <td>CGT</td> <td>CONO GRANDE BIFRONTI Ø 110-165 MM</td> <td>339672</td> </tr> </table>	DPT	FLANGIA DISTANZIALE PER APPOGGIO CERCHI FURGONI	341843	CGT	CONO GRANDE BIFRONTI Ø 110-165 MM	339672																		
DPT	FLANGIA DISTANZIALE PER APPOGGIO CERCHI FURGONI	341843																							
CGT	CONO GRANDE BIFRONTI Ø 110-165 MM	339672																							





ACCESSORI EQUILIBRATICI A BANCO PER AUTOCARRI

immagine	Descrizione	Codice	ET1680	ET1650	ET1450 MO	ET1450 HS	ET88	ET77
CENTRAGGIO E BLOCCAGGIO RUOTA								
	GGR 223 Accessorio di centraggio per ruote con foro centrale da Ø 190 a 223 mm, con cerchi Ø 17,5-19,5" (IVECO - MAN - DAF)	8-21100222	-	-	-	-	○	○
 DFT	DFT Distanziale per ruote F350/450 da usare con ARFT	802245527	-	-	-	-	○	○
 FTA CMT CPT	ARU Accessorio base di centraggio per ruote auto	802247782	-	-	-	-	○	○
	FTA	FLANGIA PER RIDUZIONE DIAMETRO APPOGGIO RUOTA VETTURA	339673					
	CPT	CONO PICCOLO Ø47-64 MM	339670					
	CMT	CONO MEDIO BIFRONTI Ø60-115 MM	339671					
	GTV Ghiera base di bloccaggio per camion e auto Ø 46 mm	802239121	-	-	-	-	○	○

ACCESSORI EQUILBRATRICI A BANCO PER AUTOCARRI

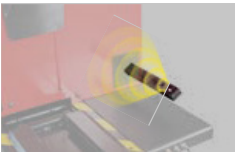
immagine	Descrizione	Codice		ET1680	ET1650	ET1450 MO	ET1450 HS	ET88	ET77
CENTRAGGIO E BLOCCAGGIO RUOTA									
	GTR Ghiera rapida di bloccaggio per camion e auto Ø 46 mm	802443938		-	-	-	-	O	O
<p>FT 1 DEB RFS CHT6</p> <p>CHI6 CEP</p>	FRU-SA D46 Flangia universale per tutte le ruote vettura e veicoli commerciali (senza foro centrale). Interasse fori da ø 90 a 210 mm	8-21100256		-	-	-	-	O	O
	FT 1	BIELLA CON PERNO	4-135110						
	CHT6	CHIAVE ESAGONALE A T CH6	4-105877						
	DEB	DADO BIFRONTE FISSAGGIO RUOTE	321878						
	CHI6	CHIAVE ESAGONALE CH6	2-00906						
	RFS	RILEVATORE INTERASSE FORI	2008177						
CEP	CHIAVE A PIPA CH 22	426517							
	MLC Manovella lancio manuale per flangia FRU-SA	802244344		-	-	-	O	-	-



ACCESSORI EQUILBRATRICI A BANCO PER AUTOCARRI

ACCESSORI EQUILBRATRICI A BANCO PER AUTOCARRI				ET1680	ET1650	ET1450 MO	ET1450 HS	ET188	ET177
immagine	Descrizione	Codice							
DISPOSITIVI ELETTRONICI									
	AWD misuratore della larghezza ruota con Sonar	8-21100293/90		O	O	-	-	-	-
NEW! 	RRS-W Radial Runout Sonar Wheel per la misura dell'eccentricità radiale dello pneumatico	8-21100300/90		O	-	-	-	-	-
NEW! 	RRS-R Radial Runout Sonar Rim per la misura dell'eccentricità radiale del cerchione. Funzione disponibile solo in presenza del kit RRS-W	8-21100301		O	-	-	-	-	-
NEW! 	LRS-W Lateral Runout Sonar Wheel per la misura dell'eccentricità laterale della spalla dello pneumatico. Funzione disponibile solo in presenza del kit RRS-W	8-21100302		O	-	-	-	-	-
 LAN CONNECTION KIT	Kit collegamento LAN	8-21100255		O	-	-	-	-	-

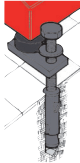

ACCESSORI EQUILBRATRICI A BANCO PER AUTOCARRI

ACCESSORI EQUILBRATRICI A BANCO PER AUTOCARRI				ET1680	ET1650	ET1450 MO	ET1450 HS	ET188	ET77
immagine	Descrizione	Codice							
DISPOSITIVI ELETTRONICI									
	AL12 - per il collegamento ad una fonte esterna a 12V	8-21101000		-	-	-	○	-	-
	KIT LASER & LED indicatore LASER e illuminatore LED	8-21100238		-	-	○	○	-	-
	KIT LASER BLADE puntatore laser integrato nel braccio rilevatore digitale interno, diametro/distanza per guidare l'operatore nella scelta dei piani interni del cerchio senza commettere errori e con estrema visibilità. Sistema Plug&Play dedicato.	8-21120022		■	■	○	○	-	-
VARIE									
	TRUCK TROLLEY KIT per un utilizzo ottimale	8-21101400		-	-	○	○	-	-
	ROLL-BAR KIT - protezione laterale	8-21101401		-	-	○	○	-	-

ACCESSORI EQUILIBRATRICI A BANCO PER AUTOCARRI

ACCESSORI EQUILIBRATRICI A BANCO PER AUTOCARRI				ET1680	ET1650	ET1450 MO	ET1450 HS	ET188	ET177
immagine	Descrizione	Codice							
VARIE									
	Supporto accessori	8-21101402		○	○	○	○	○	○
	KFTU Kit - set di fisher e staffe per fissare l'equilibratrice al pavimento	8-21101010		-	-	○	○	-	-
	KIT INDUSTRIA 4.0: Kit stand alone per la diagnosi dell'eccentricità radiale ruota collegabile alla rete aziendale dell'officina	8-21101403		-	-	○	○	○	○
	PRT Protezione ruota	802260829		-	-	-	-	○	○

ACCESSORI EQUILBRATRICI A BANCO PER AUTOCARRI

ACCESSORI EQUILBRATRICI A BANCO PER AUTOCARRI				ET1680	ET1650	ET1450 MO	ET1450 HS	ET88	ET77
immagine	Descrizione	Codice							
VARIE									
	AWR Utensile per la rimozione dei pesi adesivi	802461006		○	○	○	○	○	○
	Monitor wide-screen 19"	8-21100235		-	-	-	-	■	-
	TWG Kit Carter protezione ruota completa di supporto	8-21100298/90		-	-	○	-	-	-



NEXION S.P.A.
STRADA STATALE 468 N° 9 - 42015 CORREGGIO - R.E. - ITALY
TEL. +39 0522 639.111 - FAX +39 0522 639.150 - WWW.CORGHI.COM - INFO@CORGHI.COM



Per aiutare il pianeta ottimizzando il consumo di carta, i nostri cataloghi sono consultabili sul sito www.corghi.com. Una stampa responsabile aiuta a preservare l'ambiente.

The manufacturer reserves the right to modify the features of its products at any time.
Code DPG000245_WB_EX -11-2024