

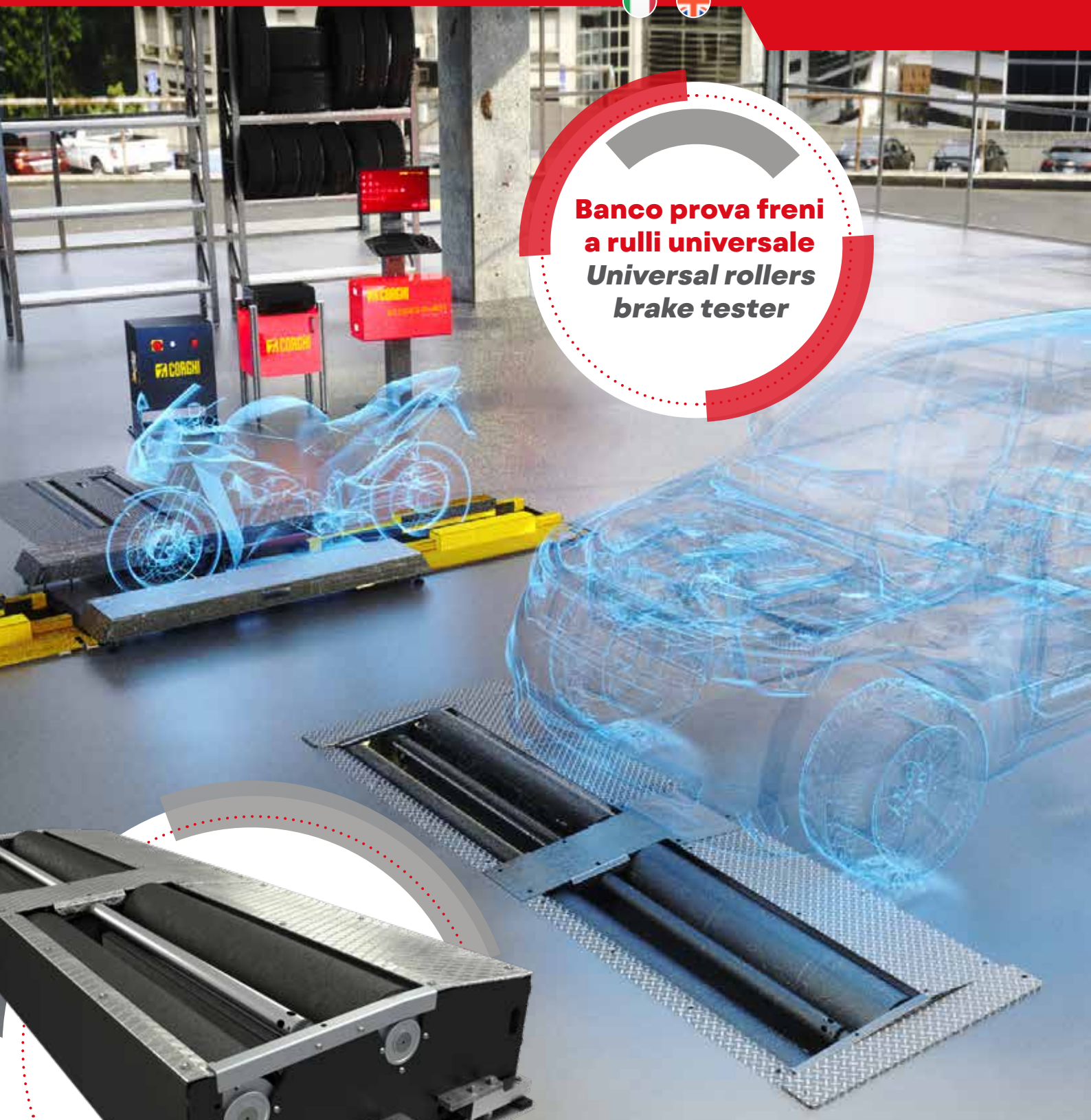

**Banco prova freni  
a rulli universale  
Universal rollers  
brake tester**



**Lo strumento ideale per  
il moderno centro di revisione  
*The ideal product for the  
advanced PTI center***



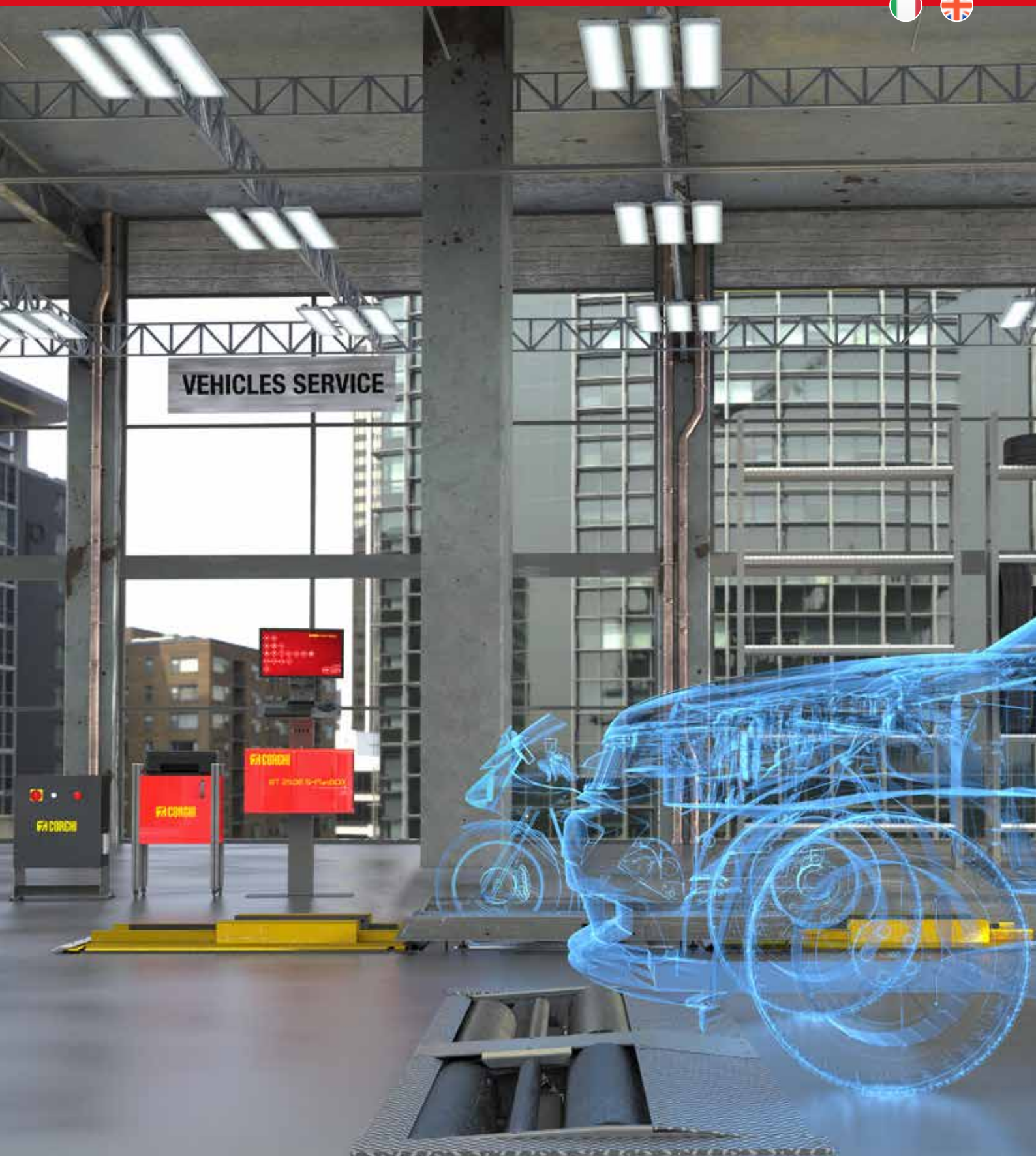

**BT 250E S - FlatBOX**  
con un'ampia serie di accessori  
soddisfa le esigenze attuali e future  
della stazione di controllo  
grazie ad un approccio  
pratico e flessibile.

**BT 250E S - FlatBOX**  
*with a wide range of accessories  
meets current and future control  
station requirements  
thanks to a practical and  
flexible approach.*

**BT 250E S - FlatBOX**

è lo strumento ideale per il moderno centro di revisione, un nuovo banco prova freni a rulli che in modo semplice ed intuitivo permette la verifica di veicoli leggeri (sino a 3,5 t) e attraverso una struttura modulare anche di quelli a 2, 3 e 4 ruote (motoveicoli e tricicli/quadricicli).

**BT 250E S - FlatBOX**

*is the ideal tool for the modern vehicle overhaul centre, a new roller brake test bench that enables the simple and intuitive testing of light vehicles (up to 3.5 t) and, thanks to its modular design, also 2, 3 and 4-wheel vehicles (motorcycles and three-wheel/four-wheel vehicles).*

La nuova progettazione lo rende uno strumento innovativo e pronto ad accogliere le più stringenti normative europee relative alle prove di frenatura.



*The new design makes it an innovative tool, ready for compliance with the most stringent European regulations on braking tests.*

Pienamente rispondente alla normativa MTCNet 2 in configurazione DIR e RETE, con il nuovo software operativo garantisce semplicità d'uso ed accuratezza delle misure.



*It strictly complies with MTCNet 2 standard in DIR and NETWORK configuration and, thanks to the new operating software, ensures ease of use and measurement accuracy.*



## CARATTERISTICHE GENERALI / GENERAL FEATURES

**Nuova bancata monoblocco per una maggiore robustezza, upgradabile.**

*New one-piece bank for greater robustness, upgradable.*

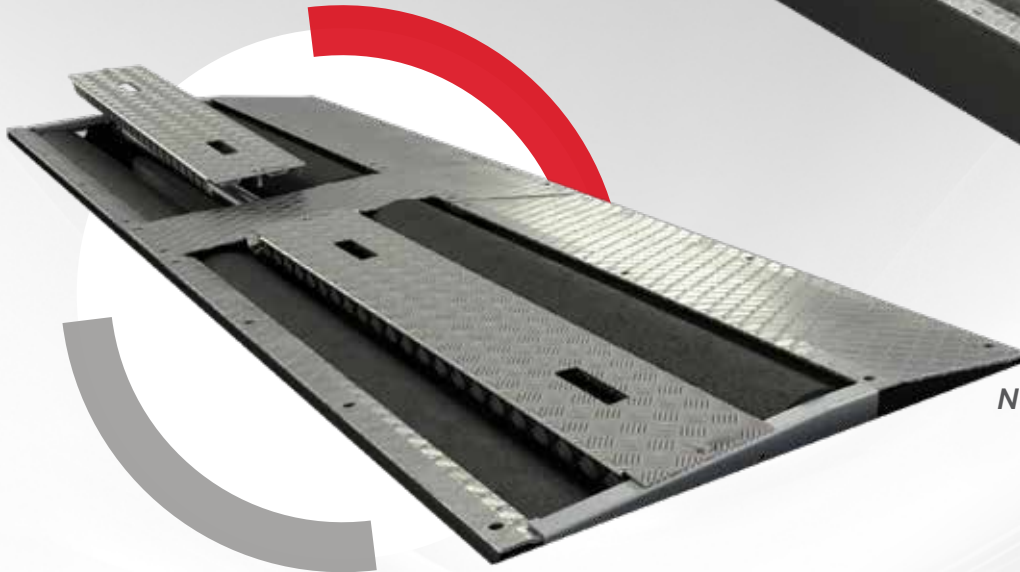
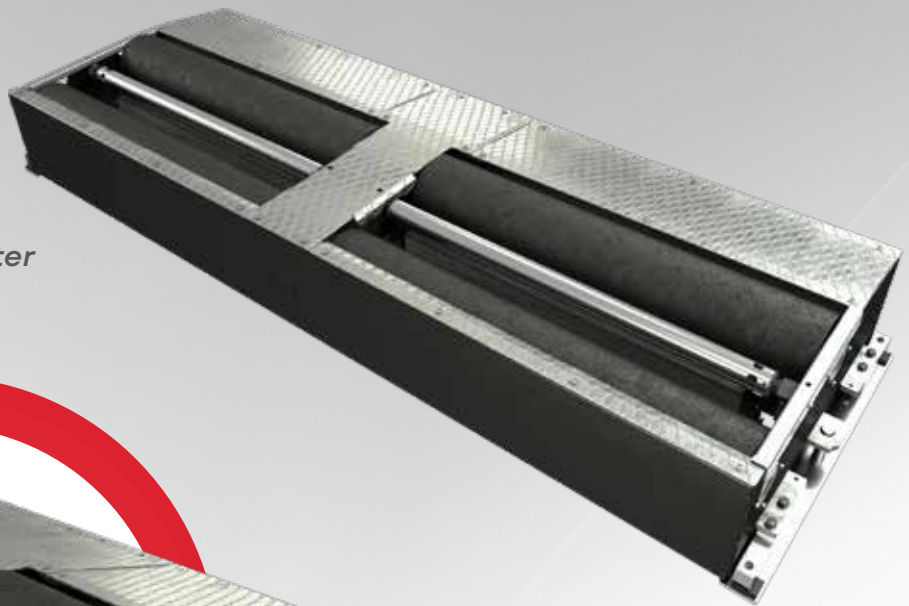

**Nuove coperture carrabili FastDrive.**

*New vehicle-accessible FastDrive covers.*

### **NUOVO CABINATO DI MISURA LCT ADV.**

Tra gli accessori è possibile scegliere quale tipo di unità centrale impiegare in configurazione pc apparecchiatura (MCTC NET 2).

La versione compatta LCT ADV riunisce in una elegante struttura tutti gli elementi necessari alla gestione del "prova freni". La stampante trova posto su di un pratico supporto carrellato.

Il controllo della bancata avviene attraverso il quadro elettrico esterno.

### **NEW CABINET COMPLIANT WITH LCT ADV MEASURES.**

*The accessories available allow to choose the type of central unit to be used in equipment PC configuration (MCTC NET 2).*

*The compact LCT ADV version combines all the elements required for "brake test" in an elegant structure. The printer is located on a convenient trolley stand.*

*The bank is controlled through the external electric panel..*





**Nuovo telecomando  
per una navigazione semplice e veloce**

*New remote control  
for easy and quick browsing.*



**Nuovo software ad icone  
per un accesso diretto a  
tutte le funzioni.**

*New icon-based  
software for direct  
access to all functions.*

**Nuova interfaccia di  
navigazione  
con monitor touch screen.**

*New browsing interface  
with touch screen monitor.*

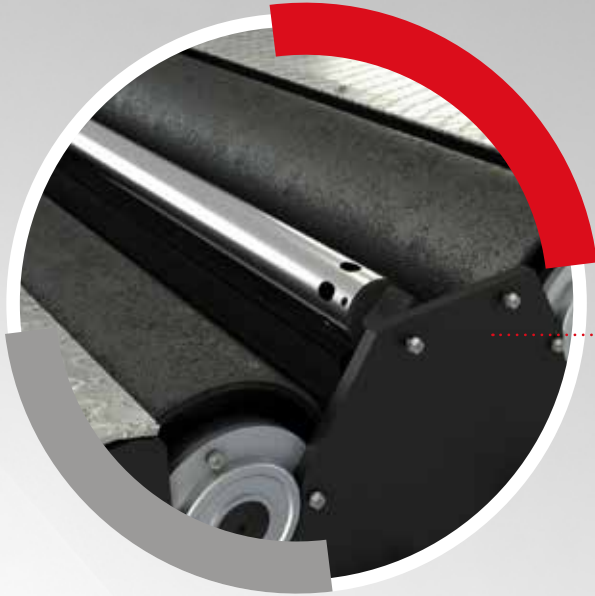

**CARATTERISTICHE MECCANICHE / MECHANICAL FEATURES**

**RIVESTIMENTO RULLI**

Il rivestimento rulli a base corindonica garantisce un corretto e durevole coefficiente di aderenza anche in caso di ruote bagnate. Il rullo posteriore è rialzato di 45 mm per garantire una maggiore stabilità durante la frenatura.

**ROLLER COATING**

*The corundum-based roller coating ensures a correct and durable coefficient of adhesion also in case of wet wheels. The rear roller is raised by 45 mm to ensure greater stability during braking.*

**SISTEMA DI PESATURA SOTTO I RULLI**

Il sistema di pesatura statico/dinamico è costituito da 4 celle di carico ad alta precisione per la rilevazione automatica dell'efficienza frenante.

**WEIGHING SYSTEM UNDER THE ROLLERS**

*The static/dynamic weighing system consists of 4 high-precision load cells for braking efficiency automatic detection.*

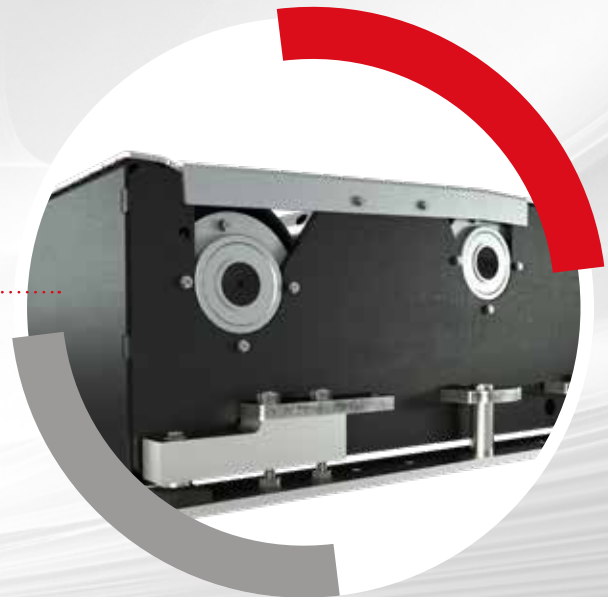
**DISTANZA MINIMA INTERNA E DISTANZA MASSIMA ESTERNA DEI RULLI**

Grazie alle caratteristiche costruttive è possibile testare un'ampia gamma di veicoli a quattro ruote, dai quad ai camper, senza nessuna difficoltà.

**ROLLER MINIMUM INTERNAL DISTANCE AND MAXIMUM INTERNAL DISTANCE**

*Thanks to the construction features, it is possible to easily test a wide range of four-wheel vehicles, including quads and campers.*

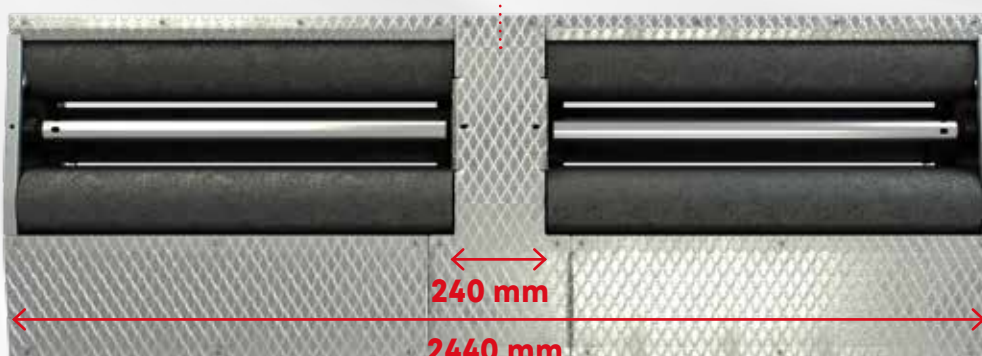

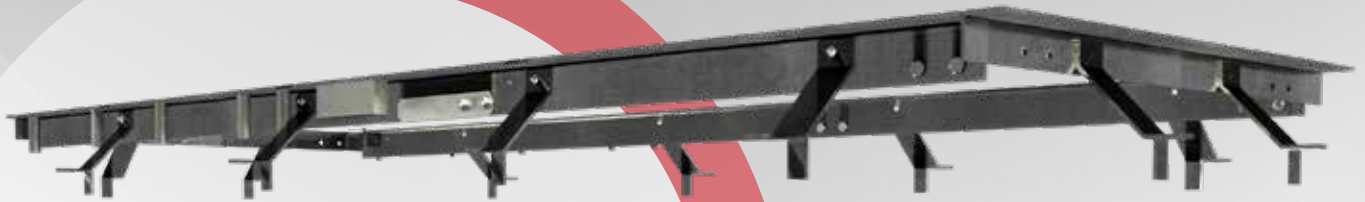

## DETTAGLI / DETAILS

**CORNICI DI MONTAGGIO PER FOSSA SINGOLA O PER FOSSA UNICA**

È disponibile una serie completa di cornici di montaggio per installazioni singole, con il solo "prova freni", oppure in configurazione unica in abbinamento al "prova velocità".

Nelle cornici sono presenti le predisposizioni per l'installazione del sistema di calibrazione e dei marciapiedi per motoveicoli a due ruote.

**MOUNTING FRAMES FOR SINGLE PIT OR UNIQUE PIT**

*A complete set of mounting frames is available for single installations, with "brake test" only or in unique configuration combined with the "speed test".*

*The frames are preset for the installation of the calibration system and platforms for two-wheel motor vehicles.*

## BT 250E S - FlatBOX



### QUADRO ELETTRICO

Il quadro elettrico di comando e gestione del "prova freni", compatto ed espandibile, è completo di un'unità di elaborazione dati e un'unità di azionamento motoriduttori. È utilizzabile in abbinamento al cabinato oppure in configurazione "dir".

### ELECTRIC PANEL

The electric control panel to control and manage the "brake test" is compact and expandable, and is complete with a data processing unit and a gear motor driving unit. It can be used in combination with the cabinet or in "dir" configuration.

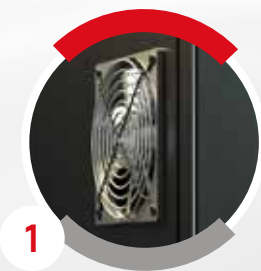

1

Predisposizione montaggio ventola di raffreddamento (in abbinamento ad inverter).

*Ready for the installation of a cooling fan (in combination with inverter).*



2

Interruttore sezionatore lucchettabile.

*Padlockable disconnect switch.*



3

Fungo di emergenza.

*Emergency mushroom-head button.*



**MODULARITÀ / MODULARITY**

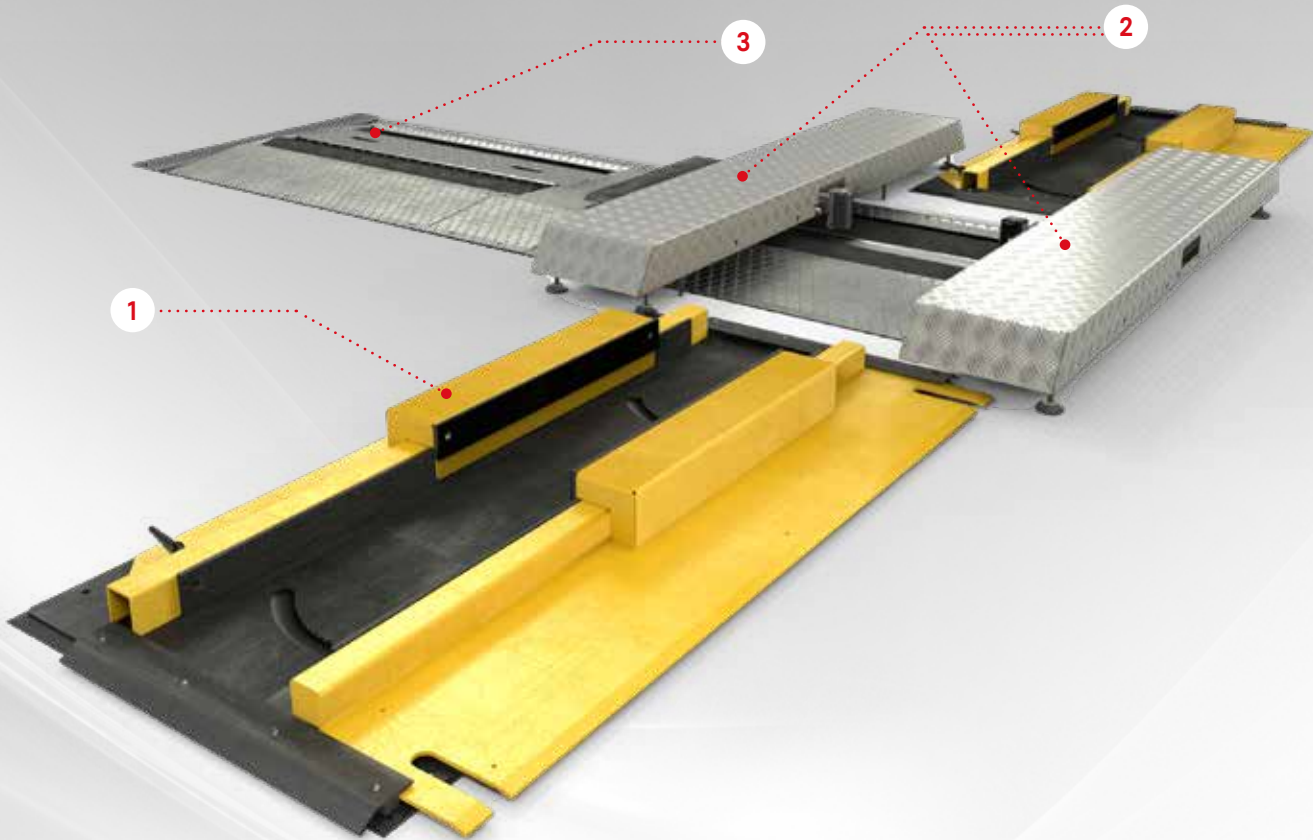

**CONFIGURAZIONE PER MOTOVEICOLI A 2, 3 E 4 RUOTE**

Una serie di accessori consente a BT 250E S - FlatBOX una verifica agevole e sicura di tutti i motoveicoli.

Nel caso dei 2 ruote prevede l'adozione anche di morse pneumatiche ribassate gestibili dal programma operativo.

I marciapiedi amovibili completano la dotazione di prova.

**CONFIGURATION FOR 2-, 3- AND 4-WHEEL MOTOR VEHICLES**

A series of accessories allows the BT 250E S - FlatBOX to be easily and safely checked on all motor vehicles.

For 2-wheel vehicles, it is also possible to use lowered pneumatic clamps that can be managed from the operating program.

The removable platforms complete the testing equipment.

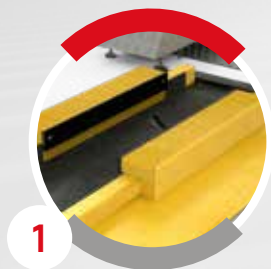

Morsa pneumatica asimmetrica ribassata.

*Lowered asymmetrical pneumatic clamp.*

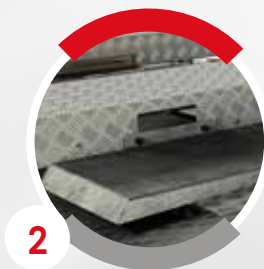

Marciapiedi amovibili.

*Removable platforms.*



Copertura "Fast drive" per semibancata non in uso.

*"Fast drive" cover for half bank not being used.*

## BT 250E S - FlatBOX



### NUOVO SOFTWARE A ICONE

Il nuovo software, completamente rinnovato, offre una modalità di navigazione chiara, facile e veloce.

Semplici icone indicano all'operatore la funzione di misura desiderata, e un'interfaccia intuitiva lo guiderà durante tutte le fasi di misurazione.

L'abbinamento al monitor touch screen (opzionale) incrementa il concetto di accesso diretto alla misurazione.

### NEW ICON-BASED SOFTWARE

The new, completely renewed software, provides a clear, easy and quick browsing mode.

Clear icons show the desired measuring function to the operator, and an intuitive interface guides him or her during all measurement steps.

Its combination with the touch screen monitor (optional) enhances the direct measurement access concept.



Caricamento facile e veloce del veicolo accettato/prenotato in contesto pc apparecchiatura (MCTC NET 2).

*Easy and quick loading of the accepted/reserved vehicle in equipment PC context (MCTC NET 2).*

Accesso diretto ed immediato alla funzione di misura desiderata.

*Direct and immediate access to the desired measurement function.*



Icone chiare ed intuitive.  
*Clear and intuitive icons.*







### **TELECOMANDO**

Nuovo telecomando multifunzionale per una navigazione facile e veloce.

Navigazione multidirezionale per una selezione immediata della funzione operativa.

### **REMOTE CONTROL**

*New multifunction remote control for easy and quick browsing.*

*Multi-directional browsing for immediate selection of the operating function.*



Navigazione multidirezionale.

*Multi-directional browsing.*

Misurazione a distanza dello sforzo all'organo di comando.

*Remote measurement of control component force.*

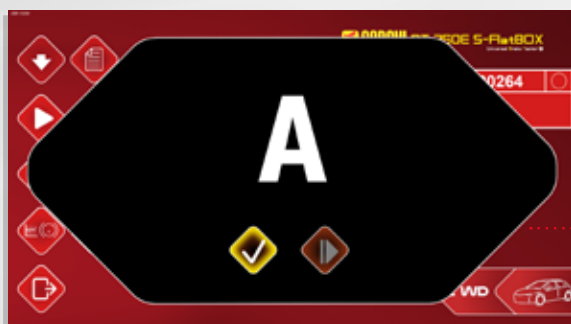

Navigazione contestuale al software operativo.

*Browsing in conjunction with the operating software.*

## ACCESSORI / ACCESSORIES

**BANCO PROVA FRENI A RULLI PER VEICOLI LEGGERI E 2-3-4 RUOTE - FLAT VERSION - BT 250E S - FLATBOX**  
**ROLLER BRAKE TEST BENCH FOR LIGHT-DUTY AND 2, 3, 4-WHEEL VEHICLES - FLAT VERSION - BT 250E S - FLATBOX**



**GRUPPO RULLI ADV FLAT**  
**ADV FLAT ROLLER UNIT**

**ACCESSORI OBBLIGATORI, CONFIGURAZIONE AUTO (configurazione minima obbligatoria per il funzionamento del banco)**  
**MANDATORY ACCESSORIES, CAR CONFIGURATION (minimum mandatory configuration for bench operation)**



**QUADRO ELETTRICO BOX FLAT**  
**BOX FLAT ELECTRIC PANEL**



**CORNICE SINGOLA PER INCASSO ADV**  
**SINGLE FRAME FOR ADV RECESSED INSTALLATION**



**KIT TELECOMANDO RADIO CT ADV**  
**CT ADV RADIO REMOTE CONTROL KIT**



**MISURATORE DI SFORZO AL PEDALE E FRENO A MANO / PEDAL AND PARKING BRAKE FORCE MEASURING GAUGE**



**KIT PERSONALIZZAZIONE BT 250E S FLATBOX AUTO / CUSTOMISATION KIT BT 250E S FLATBOX CARS**

**OPZIONE MOTOVEICOLI A 2 RUOTE / OPTION FOR 2-WHEEL MOTOR VEHICLES**



**KIT PERSONALIZZAZIONE BT 250E S FLATBOX MOTO / CUSTOMISATION KIT BT 250E S FLATBOX MOTORCYCLES**



**COPPIA DINAMOMETRI MOTO / PAIR OF DYNAMOMETERS FOR MOTORCYCLES**



**KIT MARCIAPIEDI PER ADV / PLATFORM KIT FOR ADV**



**COPERTURA CARRABILE PER ADV (1 PEZZO) / VEHICLE-ACCESSIBLE COVER FOR ADV (1 PIECE)**



**KIT FISSAGGIO DI SICUREZZA VEICOLO (IN ALTERNATIVA ALLE MORSE PNEUMATICHE)**  
**VEHICLE SAFETY FASTENING KIT (ALTERNATIVE TO PNEUMATIC CLAMPS)**



**KIT CALIBRAZIONE COMPLETO / COMPLETE CALIBRATION KIT**



**OPZIONE VEICOLI 3/4 RUOTE / OPTION FOR 3/4-WHEEL VEHICLES**

 **KIT PERSONALIZZAZIONE BT 250E S FLATBOX 3/4 RUOTE / CUSTOMISATION KIT BT 250E S FLATBOX 3/4 WHEELS**

 **KIT COMPLETAMENTO 3/4 RUOTE / 3/4 WHEELS COMPLETION KIT**

 **COPPIA DINAMOMETRI MOTO / PAIR OF DYNAMOMETERS FOR MOTORCYCLES**

 **COPERTURA CARRABILE PER ADV (1 PEZZO) / VEHICLE-ACCESSIBLE COVER FOR ADV (1 PIECE)**

 **KIT CALIBRAZIONE COMPLETO / COMPLETE CALIBRATION KIT**

**ACCESSORI ADDIZIONALI / ADDITIONAL ACCESSORIES**

**CABINATO UNIVERSALE LCT ADV RAL 2004 BUCCIATO  
UNIVERSAL LCT ADV CABINET, RAL 2004 TEXTURED FINISH**



**PC APPARECCHIATURA (WIN 10) / EQUIPMENT PC (WIN 10)**



**MONITOR A COLORI LCD 19" WIDESCREEN / 19" WIDE SCREEN LCD COLOUR MONITOR**



**MONITOR TOUCH SCREEN 22" / 22" TOUCH SCREEN MONITOR**



Accessori obbligatori.  
*Compulsory accessories.*



Accessori opzionali.  
*Optional accessories.*





Accessori obbligatori nel caso di opzione MOTOVEICOLI A 2 RUOTE e/o VEICOLI 3/4 RUOTE. Nel caso venissero installate entrambe le opzioni è necessario acquistare un solo elemento contrassegnato che verrà utilizzato sia per l'opzione MOTOVEICOLI A 2 RUOTE che per VEICOLI 3/4 RUOTE.

*Compulsory accessories in case of 2-WHEEL VEHICLES and/or 3/4-WHEEL VEHICLES option. If both options are installed, it is necessary to purchase only one marked element, that will be used both for 2-WHEEL and 3/4-WHEEL VEHICLES options.*

## ACCESSORI ADDIZIONALI / ADDITIONAL ACCESSORIES

-  **KIT SUPPORTO FISSO MONITOR LCD / LCD MONITOR FIXED SUPPORT KIT**
-  **KIT STAMPANTE A COLORI A4 A GETTO DI INCHIOSTRO / INKJET COLOUR A4 PRINTER KIT**
-  **KIT PERSONALIZZAZIONE PER CABINATO LCT ADV CORGHI / CUSTOMISATION KIT FOR LCT ADV CORGHI CABINET**
-  **MOBILETTO PER STAMPANTE / PRINTER SUPPORT**
-  **COPERTURA CARRABILE PER ADV (1 PEZZO) / VEHICLE-ACCESSIBLE COVER FOR ADV (1 PIECE)**
-  **CORNICE DI MONTAGGIO IN FOSSA UNICA PER ADV (CON PROVA VELOCITÀ)  
MOUNTING FRAME IN UNIQUE PIT FOR ADV (WITH SPEED TEST)**
-  **KIT MARCIAPIEDI PER ADV PER INSTALLAZIONE IN FOSSA UNICA  
PLATFORM KIT FOR ADV FOR INSTALLATION IN UNIQUE PIT**
-  **COPPIA DI MORSE PNEUMATICHE ASIMMETRICHE RIBASSATE DA INCASSO  
(IN ALTERNATIVA AL KIT FISSAGGIO DI SICUREZZA)  
PAIR OF LOWERED ASYMMETRICAL PNEUMATIC CLAMPS FOR RECESSED INSTALLATION  
(ALTERNATIVE TO SAFETY FASTENING KIT)**
-  **CORNICE DA INCASSO PER MORSA PNEUMATICA ASIMMETRICA (1 PEZZO)  
RECESSED FRAME FOR ASYMMETRICAL PNEUMATIC CLAMP (1 PIECE)**
-  **OPZIONE MORSE PNEUMATICHE PER QE (DA INSTALLARE IN ABBINAMENTO ALLE MORSE PNEUMATICHE)  
OPTION, PNEUMATIC CLAMPS FOR EP (TO BE INSTALLED IN COMBINATION WITH THE PNEUMATIC CLAMPS)**

 Accessori obbligatori.  
*Compulsory accessories.*

 Accessori opzionali.  
*Optional accessories.*

 Accessori obbligatori nel caso di opzione MOTOVEICOLI A 2 RUOTE e/o VEICOLI 3/4 RUOTE. Nel caso venissero installate entrambe le opzioni è necessario acquistare un solo elemento contrassegnato che verrà utilizzato sia per l'opzione MOTOVEICOLI A 2 RUOTE che per VEICOLI 3/4 RUOTE.

*Compulsory accessories in case of 2-WHEEL VEHICLES and/or 3/4-WHEEL VEHICLES option. If both options are installed, it is necessary to purchase only one marked element, that will be used both for 2-WHEEL and 3/4-WHEEL VEHICLES options.*



**DATI TECNICI-SPECIFICHE TECNICHE / TECHNICAL DATA-TECHNICAL SPECIFICATIONS**

Bancata rulli per utilizzo su veicoli leggeri ( $\leq 3,5$ t) <i>Roller bank for use on light-duty vehicles (<math>\leq 3.5</math> t)</i>		Dato / Value
Dimensioni (mm) / <i>Dimensions (mm)</i>		888 x 2.520 x 310
Peso (Kg) / <i>Weight (Kg)</i>		700
Telaio / <i>Frame</i>		Verniciato con polveri epossidiche anticorrosive. Ricoperture passaggi ruota zincati. <i>Painted with anti-corrosion epoxy powders. Galvanised wheel passage covers.</i>
Lunghezza utile dei rulli (mm) / <i>Roller useful length (mm)</i>		1.100
Distanza interna rulli (mm) / <i>Roller internal distance (mm)</i>		240
Distanza esterna rulli (mm) / <i>Roller external distance (mm)</i>		2.440
Carico ammissibile per asse al passaggio (N) <i>Permitted load per axle upon passage (N)</i>		30.000
Carico ammissibile in prova per asse (N) <i>Permitted load per axle during testing (N)</i>		20.000
Diametro rulli (mm) / <i>Roller diameter (mm)</i>		202
Interasse rulli (mm) / <i>Roller centre distance (mm)</i>		370
Velocità periferica rulli a vuoto (km/h) / <i>Zero-load roller peripheral speed (km/h)</i>		5,3
Disassamento verticale (mm) / <i>Vertical set back (mm)</i>		45
Coefficiente di aderenza / <i>Coefficient of adhesion</i>		$\geq 0,7$ anche a rulli bagnati $\geq 0.7$ even with wet rollers
Potenza motori (kW) / <i>Motor power (kW)</i>		4
Sistema di uscita veicolo dai rulli / <i>Vehicle exit from rollers system</i>		Avviamento dei rulli / Freno sul motore elettrico <i>Roller start-up / Brake on electric motor</i>

Caratteristiche per impiego specifico su motoveicoli 2 e 3/4 ruote <i>Features for specific use on 2-wheel and 3/4-wheel motor vehicles</i>		Dato / Value
Lunghezza utile dei rulli (mm) A MEZZO DI KIT SPECIFICO per soli veicoli a 2 ruote <i>Roller useful length (mm) THROUGH SPECIFIC KIT for 2-wheel vehicles only</i>		400
Carico ammissibile in prova per asse (N) / <i>Permitted load per axle during testing (N)</i>		5.000

Sistema di bloccaggio ruota per motoveicoli a due ruote / <i>Wheel clamping system for two-wheel motor vehicles</i>	
Morse pneumatiche / <i>Pneumatic clamps</i>	Morse pneumatiche ribassate gestite dal programma operativo <i>Lowered pneumatic clamps managed by the operating program</i>
Sistema a cinghie / <i>Belt system</i>	Fissaggio manuale a cinghia della ruota non in prova <i>Manual belt fastening of the wheel not being tested</i>

Caratteristiche elettriche / <i>Electrical features</i>	
Alimentazione / <i>Power supply</i>	400 V / 3 Ph / 50 Hz
Potenza nominale / <i>Rated power</i>	2 x 4 Kw
Potenza massima assorbita / <i>Maximum absorbed power</i>	18 Kw

Compatibilità MCTCNET2 / <i>MCTCNET2 compatibility</i>	
BT 250E S - FlatBOX	DIR / RETE



## DATI TECNICI-SPECIFICHE TECNICHE / TECHNICAL DATA-TECHNICAL SPECIFICATIONS

Caratteristiche metrologiche per utilizzo su veicoli leggeri ( $\leq 3,5$ t) <i>Metrological features for use on light-duty vehicles (<math>\leq 3.5</math> t)</i>	Udm Udm	Caratteristiche - precisione <i>Features - precision</i>
Fondo scala di misura della forza frenante (singola ruota) <i>Braking force measurement full scale (single wheel)</i>	N	6.000
Fondo scala di misura dispositivo pesatura (asse) <i>Weighing device measurement full scale (axle)</i>	N	25.000
Fondo scala di misura dello sforzo al comando pedale <i>Measurement full scale of pedal control force</i>	N	800
Fondo scala di misura dello sforzo al comando freno di stazionamento <i>Measurement full scale of clamping brake control force</i>	N	800
Precisione di misura per sforzo frenante (limite errore globale fra 0 e 40°C) <i>Measurement precision for braking effort (global error limit between 0 and 40°C)</i>	%	$\pm 50$ N sino a 3.500 N; $\pm 1,6\%$ valore misurato sino a 6.000 N $\pm 50$ N up to 3,500 N; $\pm 1.6\%$ measured value up to 6,000N
Precisione di misura per forza peso (limite errore globale fra 0 e 40°C) <i>Measurement precision for weight force (global error limit between 0 and 40°C)</i>	%	$\leq 2\%$ per valori fino a 10.000 N $\leq 2\%$ for values up to 10,000 N
Precisione di misura per sforzo al comando Manuale /Pedale (limite errore globale fra 0 e 40°C) <i>Measurement precision for Manual control/Pedal force (global error limit between 0 and 40°C)</i>	%	$\leq 1\%$ FS per valori fino a 500 N $\leq 1\%$ FS for values up to 500 N
Taratura dello zero / <i>Automatic zero</i>		automatica, prima dell'avvio test <i>calibration before test start</i>
Misurazione delle forze / <i>Force measurement</i>	/	basata su celle di carico estensimetriche <i>based on strain gauge load cells</i>
Risoluzione dissimmetria di frenatura / <i>Braking dyssimmetry resolution</i>	%	$\leq 1$
Misura del peso / <i>Weight measurement</i>		misurazione del peso asse attraverso il sistema di pesatura installato sotto la bancata <i>axle weight measurement through the weighing system installed under the bank</i>

Caratteristiche metrologiche per utilizzo su motoveicoli a 2 ruote, tricicli quadricicli leggeri <i>Metrological features for use on 2-wheel motor vehicles, light-duty three-wheel and four-wheel vehicles</i>	Udm Udm	Caratteristiche - precisione <i>Features - precision</i>
Fondo scala di misura della forza frenante (singola ruota) <i>Braking force measurement full scale (single wheel)</i>	N	3.000
Fondo scala di misura dispositivo pesatura (asse) <i>Weighing device measurement full scale (axle)</i>	N	5.000
Fondo scala di misura dello sforzo al comando pedale <i>Measurement full scale of pedal control force</i>	N	300
Fondo scala di misura dello sforzo al comando freno di stazionamento <i>Measurement full scale of clamping brake control force</i>	N	500
Precisione di misura per sforzo frenante (limite errore globale fra 0 e 40°C) <i>Measurement precision for braking effort (global error limit between 0 and 40°C)</i>	%	$\pm 20$ N sino a 1.000 N; $\pm 2\%$ valore misurato sino a 3.000 N $\pm 20$ N up to 1,000 N; $\pm 2\%$ measured value up to 3,000 N
Precisione di misura per forza peso (limite errore globale fra 0 e 40°C) <i>Measurement precision for weight force (global error limit between 0 and 40°C)</i>	%	$\pm 20$ N sino a 1.000 N; $\pm 2\%$ valore misurato sino a 5.000 N $\pm 20$ N up to 1,000 N; $\pm 2\%$ measured value up to 5,000 N

Fotografie, caratteristiche ed i dati tecnici non sono vincolanti, possono subire modifiche senza preavviso.  
*The manufacturer reserves the right to modify the features of its products at any time.*

