

B — Test Freni
S — Test Sospensioni
O — Test Deriva

F4 — Dati Finali
F12 — Grafici Finali
5 — 2WD / 4WD

Linee Revisione Vetture Safety Test Line

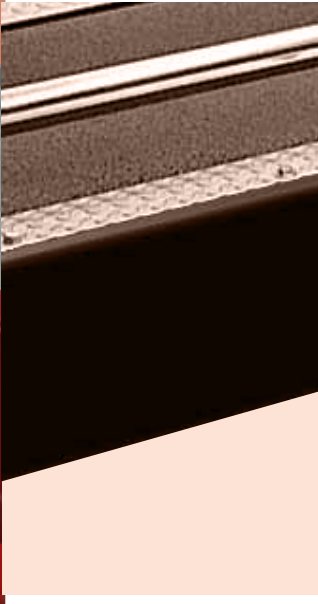
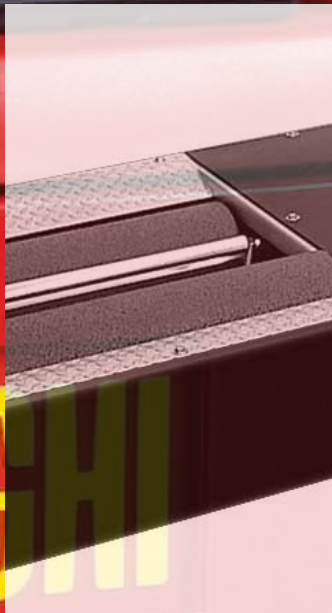
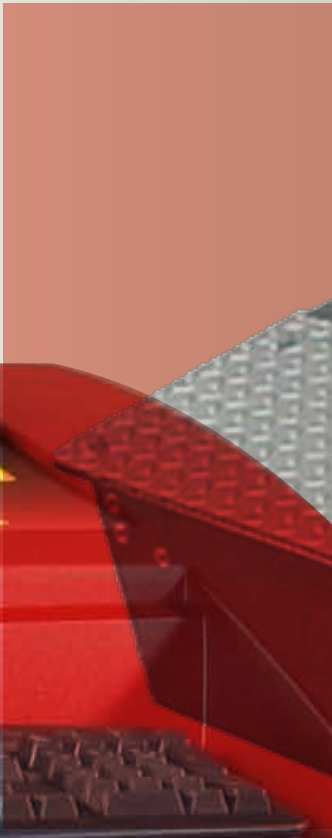

BT100

Prova freni BT 100 e BT90 per vetture e veicoli commerciali leggeri fino ad un peso massimo di 4000 kg per asse. Tecnicamente avanzati, sono completamente gestiti da un personal computer con sistema operativo Windows. La rilevazione dei dati è elettronica ed è basata sull'uso di celle di carico di tipo estensimetrico che garantiscono una elevatissima precisione di misura, una grande affidabilità e una notevole resistenza ai sovraccarichi.

The BT 100 and BT90 for cars and vans up to a maximum weight of 4,000 kg per axle. Technologically at the state of the art, are fully controlled by a personal computer with Windows operating system. Data acquisition is electronic and is based on the use of extensimetric load cells, assuring outstandingly precise measurements, excellent reliability and impressive resistance to overloads.



➤ Bancata rulli con rivestimento in resina epossilica e silice. Lunga durata, massimo rispetto del pneumatico. Disponibile la versione "ICE" con cordonatura saldata.

Roller bench covered with epoxy resin and silica. Long lifespan, utmost respect for the tyre. The "ICE" version with welded creasing is also available.

BT90

Il banco prova freni può effettuare prove anche sui veicoli dotati di ABS e su quelli dotati di trazione integrale permanente 4WD.

Può essere utilizzato singolarmente o trasformato in linea completa di controllo tecnico.

E' disponibile anche il programma per la gestione dei controlli visivi. Può inoltre essere collegato in rete ad altre unità PC e consente di gestire, tramite collegamento seriale, ulteriori apparecchiature di diagnosi come: analizzatore gas, opacimetro, fonometro, contagiri, prova sospensioni, prova deriva.

The brake test bench can also perform tests on vehicles equipped with ABS, and those with permanent 4WD.

It can be used individually or transformed into a complete vehicle testing line.

A program for managing visual inspections is also available. Additionally, it can be network-connected to other PCs, and using serial connections can manage additional testing equipment such as gas analysers, opacimeters, phonometers, rpm-counters, suspension testers and side slips.



- **Telecomando radio o IR**
permette di eseguire la prova dal veicolo e di collegare il pedale pressometrico del freno



Infrared or radio remote control
It allows vehicle testing and the connection of the pressure-metric brake pedal



- WP4000 dispositivo di pesatura per singole ruote
WP4000 device for weighing individual tyres

Centro linee di revisione multitasking
Multitasking testing line centre

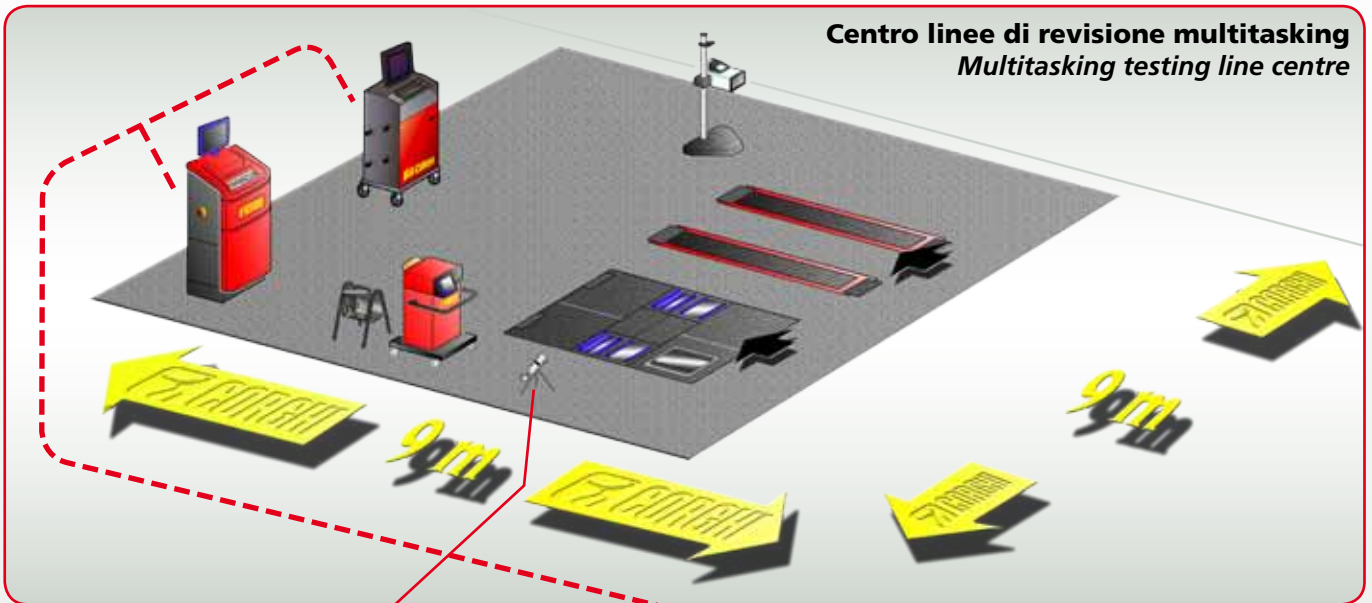

➤ **Fonometro**
Phonometer



➤ **HT970**
 Centrafari elettronico con collimatore laser e interfaccia PC
HT970 Electronic headlight aligner with laser collimator and PC interface



GA560 <
 Analizzatore gas a valigetta con sonda di temperatura e pinza induttiva
GA560
 Portable gas analyser with temperature gauge and inductive pliers



Stazione server con programma ORGANIZER XP per la gestione delle revisioni
Server station with ORGANIZER XP program for managing adjustments

Centro linee di revisione ad incasso
In-floor testing line centre

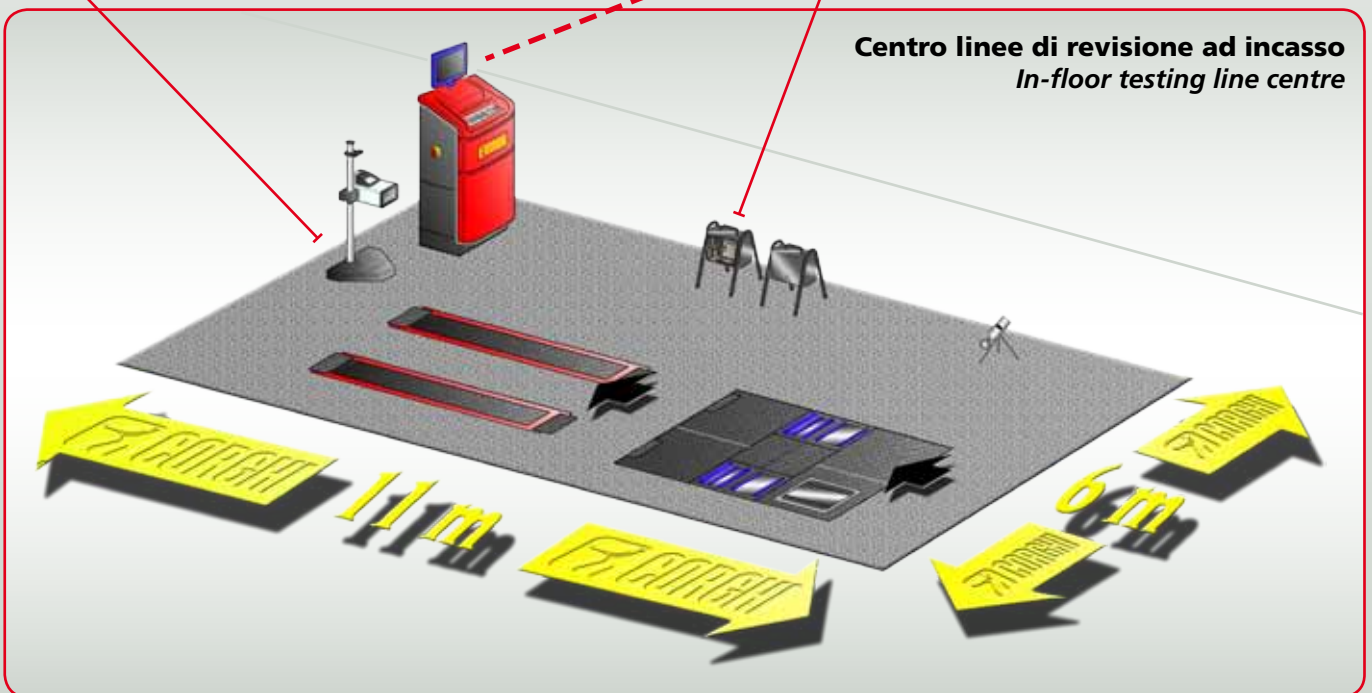



➤ **GA570**
Stazione indipendente per l'analisi dei gas di scarico collegabile anche a PC

GA570
Independent station for exhaust gas analysis which can also be connected to a PC.



➤ **OP660**
Opacimetro a valigetta con contagiri e sonda di temperatura

OP660
Portable opacimeter with rpm counter and temperature gauge

Centro linee di revisione in linea a pavimento
On-floor in-line testing line centre

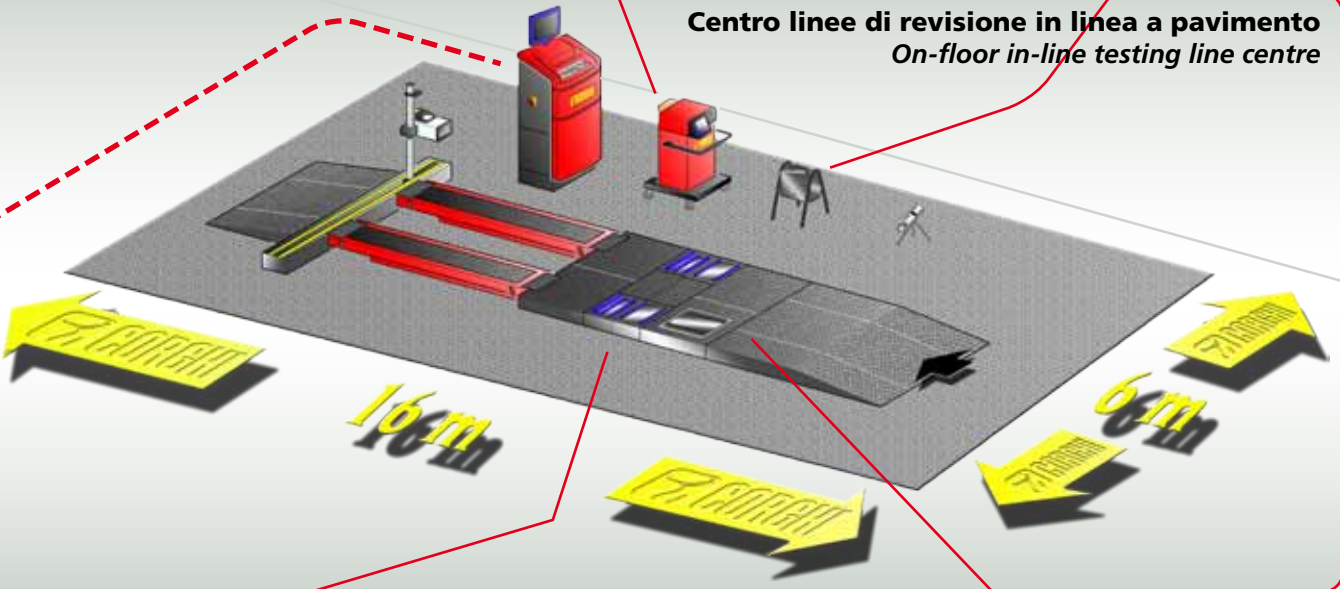

➤ **Banco prova sospensioni ST200 NX**
Progettato per la misura dell'aderenza della singola ruota secondo il metodo EUSAMA. Integrato nella linea permette di pesare il veicolo. Disponibile anche in versione Stand alone.

Suspension test bed ST200 NX
Designed to measure the adherence of individual tyres, according to the EUSAMA method. If integrated into the line, it allows to weigh the vehicle. Also available in a stand alone version.

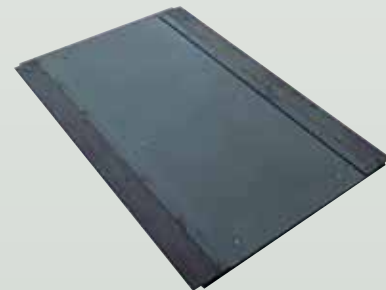

➤ **SS300**
Banco prova deriva dinamica per vettura

SS300
Dynamic side slip for vehicles



> **ORGANIZER XP**

Programma di prenotazione e raccolta dati per PC server intuitivo, completo di tutte le funzionalità per l'officina
ORGANIZER XP

An intuitive program for a PC server for reservations and data collection, which includes all the tools for a workshop.



> **PC STAZIONE**

PC stazione e multitasking per singole prove

> **VEHICLE SELECTION**

Vehicle selection and multitasking for individual checks.



> **Programma Provacfreni**

Stazione del prova freni o delle stazioni multitasking. Consente l'esecuzione delle singole prove.

Brake test Program

Station for testing brakes, or for multitasking. Allows the performance of individual checks.



> **Programma Provasospensioni**

Misura dell'aderenza della singola ruota secondo il metodo EUSAMA.

Suspension check Program

Measures the adherence of individual tyres, according to the EUSAMA method.



- > Analisi 5 gas con acquisizione temperatura e giri motore.
Analyses 5 gases as well as obtaining the temperature and measuring the rpm.



- > Analisi opacità
Opacity analysis

Controlli Visivi	
Dispositivi di Frenatura	R
Sterzo e Volante	R
Visibilità	R
Impianto Elettrico	R
Assi, Route, Pneumatici e Sospensioni	R
Telaio ed Elementi Fissati al Telaio	R
Altri Equipaggiamenti	R
Effetti Nocivi	R
Identificazione Veicolo	R

Esci

- > Controllo visivo del veicolo
Visual check of the vehicle

CORCHI Visual Control		
1	Braking device	✓
2	Steering wheel	✓
3	Visibility	✓
4	Electrical System	✓
5	Axles Wheels Pneumatics and Suspensions	✓
6	Chassis and fastened to chassis	✓
7	Other equipments	✓
8	Noxious Effects	✓
9	Vehicle Identification	✓

F7 - HELP S - PRINT Esc - EXIT



- > Misura e regolazione dei fanali
Headlights measurement and alignment

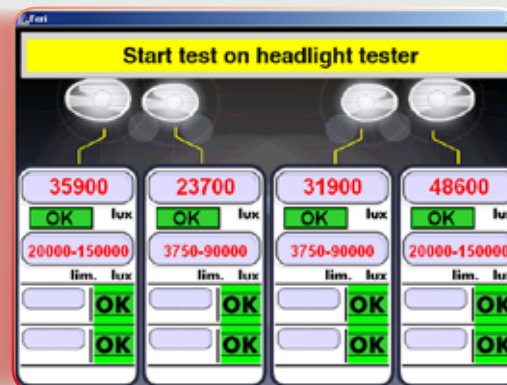

- > Analisi rumorosità allo scarico e misura del clacson
Noise analysis of the exhaust pipe and of the hooter

Caratteristiche - Characteristics

- Resistenza al rotolamento
- Ovalizzazione dei freni
- Differenza valori medi di ovalizzazione
- Forza massima di frenatura
- Forza esercitata sui dispositivi di azionamento dell'impianto frenante (se si utilizza l'apposito dinamometro a pedale)
- Efficienza frenante complessiva del veicolo e delle singole ruote (freno di servizio e di soccorso)
- Efficienza frenante del freno di stazionamento
- Squilibrio massimo di frenatura, in percentuale, fra le due ruote dello stesso asse
- Differenza fra le forze esercitate sul pedale per bloccare le ruote anteriori e posteriori (se si utilizza l'apposito dinamometro a pedale)
- Pesa integrata nel prova sospensioni oppure pesa a pedana indipendente.
- Rolling Resistance
- Brake ovalisation
- Mean ovalisation value difference
- Maximum braking force
- Effort applied to the brake system operating devices (if the pedal dynamometer is used)
- Braking efficiency of the vehicle overall and of the individual wheels (service and emergency brake)
- Parking brake braking efficiency
- Maximum percentage braking unbalance between the two wheels on the same axle
- Difference between the amounts of effort applied to the pedal to completely stop the front and rear wheels (if the pedal dynamometer is used)
- Weighing system integrated in suspension test bed or independent runway weighing system.



Dati Tecnici

BT100

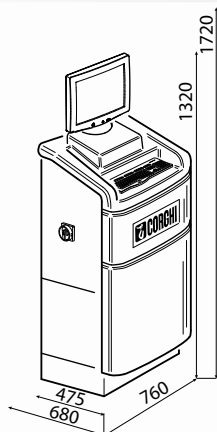

- Tensioni di alimentazione: 400 V / 3Ph/ 50Hz + 230 V / 1Ph/50Hz tensioni diverse su richiesta
- Potenza motori: 2x4,8 kW
- Carico massimo per asse: 4000 kg
- Potenza massima assorbita dal banco di prova 18 kW
- Carreggiata minima del veicolo: 800 mm
- Carreggiata massima del veicolo: 2200 mm
- Lunghezza rulli: 700 mm
- Diametro rulli: 200 mm
- Interasse rulli: 428 mm
- Velocità nominale di prova: > 5 Km / h
- Ricopertura rulli: Resina epossidica con polvere di quarzo
- Coefficiente di attrito: $\geq 0,7$ su asciutto
- Campo di misura: 0 - 6000 N versione NFR 0,8000 N
- Temperatura di esercizio: 0° - 40° C
- Dimensioni del gruppo rulli: 2320 x 890 x 305 mm
- Peso del gruppo rulli: 465 kg
- Peso cabinato e strumentazione 150 kg

- Power supply voltages: 400 V / 3Ph/ 50Hz + 230 V / 2Ph/50Hz various voltages on request
- Motor power: 2x4,8 kW
- Maximum load per axle: 3,500 kg
- Maximum power absorbed by the test bench 18 kW
- Vehicle minimum tread: 800 mm
- Vehicle maximum tread: 2,200 mm
- Roller length: 700 mm
- Roller diameter: 200 mm
- Roller centre distance: 428 mm
- Nominal testing speed: > 5 km / h
- Roller coating: Epoxy resin with powdered quartz
- Friction coefficient: $\geq 0,7$ on dry surfaces
- Measuring range: 0 - 6,000 N
- Operating temperature: 0° - 40° C
- Roller assembly dimensions: 888 x 310 x 2,320 mm
- Roller assembly weight: 465 Kg
- Equipment and mobile weight 150 Kg

Technical Data

BT90

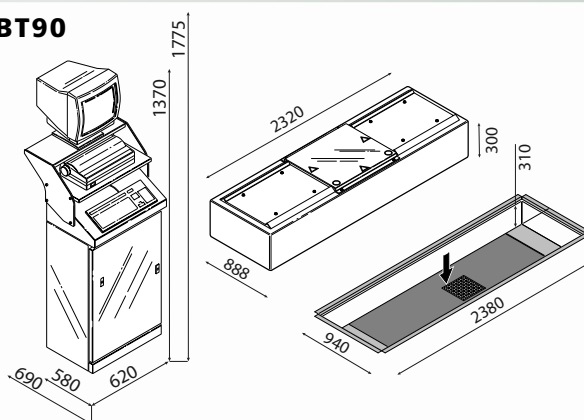

- Tensioni di alimentazione: 400 V / 3Ph/ 50Hz + 230 V / 1Ph/50Hz
- Potenza motori: 2x3 kW
- Carico massimo per asse: 4000 kg
- Potenza massima assorbita dal banco di prova 18 kW
- Carreggiata minima del veicolo: 800 mm
- Carreggiata massima del veicolo: 2200 mm
- Lunghezza rulli: 700 mm
- Diametro rulli: 200 mm
- Interasse rulli: 428 mm
- Velocità nominale di prova: > 5 Km / h
- Ricopertura rulli: Resina epossidica con polvere di quarzo
- Coefficiente di attrito: $\geq 0,7$ su asciutto
- Campo di misura: 0 - 6000 N NFR version 0,8000 N
- Temperatura di esercizio: 0° - 40° C
- Dimensioni del gruppo rulli: 2320 x 890 x 305 mm
- Peso del gruppo rulli: 465 kg
- Peso cabinato e strumentazione 150 kg

- Power supply voltages: 400 V / 3Ph/ 50Hz + 230 V / 2Ph/50Hz various voltages on request
- Motor power: 3 kW
- Maximum load per axle: 3,500 kg
- Maximum power absorbed by the test bench 18 kW
- Vehicle minimum tread: 800 mm
- Vehicle maximum tread: 2,200 mm
- Roller length: 700 mm
- Roller diameter: 200 mm
- Roller centre distance: 428 mm
- Nominal testing speed: > 5 km / h
- Roller coating: Epoxy resin with powdered quartz
- Friction coefficient: $\geq 0,7$ on dry surfaces
- Measuring range: 0 - 8,000 N
- Operating temperature: 0° - 40° C
- Roller assembly dimensions: 888 x 310 x 2,320 mm
- Roller assembly weight: 465 Kg
- Equipment and mobile weight 150 Kg